

ergotron®

StyleView® SV43 with LCD Mount

Tools Needed

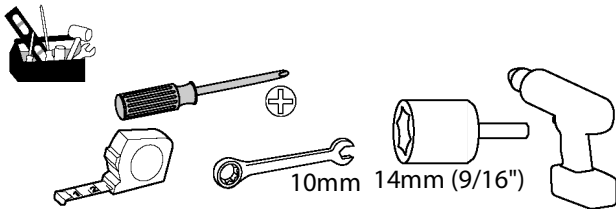

Components

	A	B
1	1x 12x	4x 3x
2	1x 1x	2x 1x
3	1x M4 x 5mm	
4	4x M4 x 10mm 8x M4 x 10mm	2x 1x
5	1x 2x M3.5 x 6mm	1x
6	4x 1x 1x	1x M4 x 8mm
7	1x 4mm	1x 3mm
8	1x	1x 1x
9	1x 1x M4 x 8mm	2x M4 x 12mm

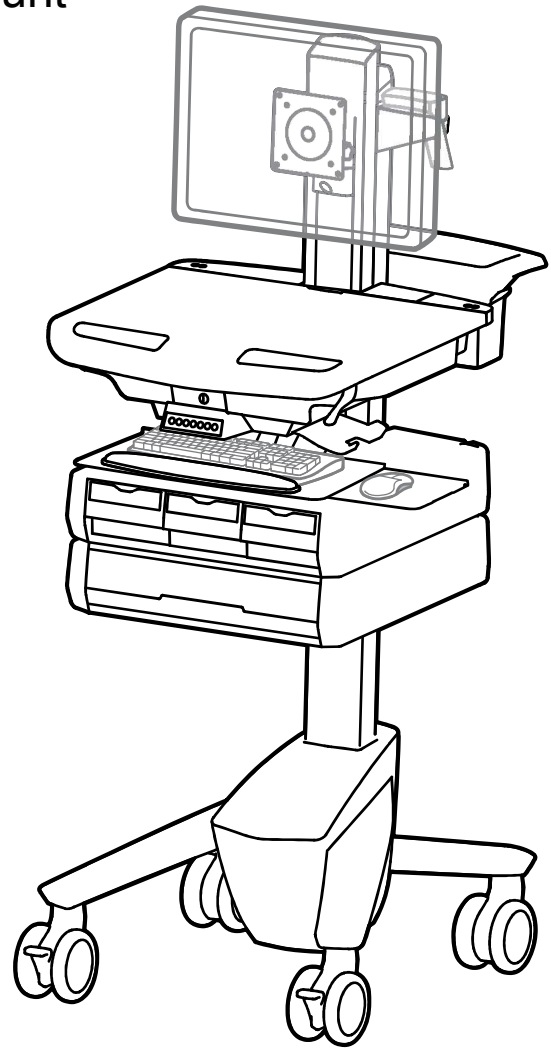

Features & Specifications.....	2 - 4
Set-up	5 - 16
Adjustment	11 - 12
Auto-Lock Drawer.....	13 - 15
Ergonomics	16
Maintenance & Safety	17 - 18

English

For the latest User Installation Guide and StyleLink Software Download please visit: www.ergotron.com

English, Español, Français, Deutsch, Nederlands, Italiano, Svenska, 日本語, 汉语

www.ergotron.com | USA: 1-800-888-8458 | Europe: +31 (0)33-45 45 600 | China: 400-120-3051 | Japan: japansupport@ergotron.com

Features & Specifications

⚠ **WARNING**
AVERTISSEMENT



Ø14mm (9/16")



IMPACT HAZARD!
MOVING PARTS CAN CRUSH AND CUT.
Failure to heed this warning may result in serious personal injury or property damage!

Minimize Lift Tension BEFORE:
Removing Mounted Equipment, Shipping Cart, Storing Cart.

DANGER D'IMPACT !
LES PARTIES EN MOUVEMENT PEUVENT ÉCRASER ET COUPER.
Il existe un risque de blessure corporelle ou d'endommagement matériel en cas de non respect de cet avertissement.

Minimisez la tension d'élévation AVANT :
de retirer l'équipement fixé, d'expédier le chariot, de stocker le chariot



www.ergotron.com

826-501

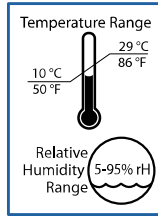
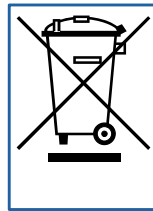

Operational

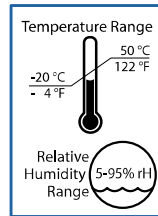

Storage

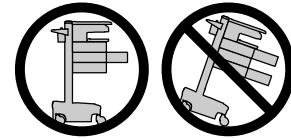

CAUTION: Close worksurface before opening drawers. Open only one drawer at a time. Do Not push cart when drawers or worksurface are open. Failure to follow these instructions may cause the cart to be unstable.

This Class A digital apparatus complies with Canadian ICES-003.

Cet appareil numérique de la classe A est conforme à la norme NMB-003 du Canada.

FCC Compliance Statement

The cart has been tested and found to comply with the limits for a Class A digital device, pursuant to part 15 of the FCC Rules. These limits are designed to provide reasonable protection against harmful interference when the equipment is operated in a commercial environment. This equipment generates, uses, and can radiate radio frequency energy and, if not installed and used in accordance with the instruction manual, may cause harmful interference to radio communications. Operation of this equipment in a residential area is likely to cause harmful interference in which case the user will be required to correct the interference at his own expense.

Changes or modifications not expressly approved by Ergotron, Inc. could void the user's authority to operate the equipment.

Please contact Ergotron for complete EMC compatibility information.

⚠ IMPORTANT! This product will need tension adjustments once installation is complete. Make sure all equipment is properly installed on the product before attempting range of motion or tension adjustments. Any time equipment is added or changed on this product resulting in a different mounted weight, you should repeat the adjustment steps to ensure safe and optimum operation. This product should move smoothly and easily through the full range of motion and stay where you set it. If movement is difficult or the product does not stay where you set it, follow the adjustment instructions to loosen or tighten the tension to create a smooth, easy motion. Depending on your product and the adjustment, it may take many turns to notice a difference.

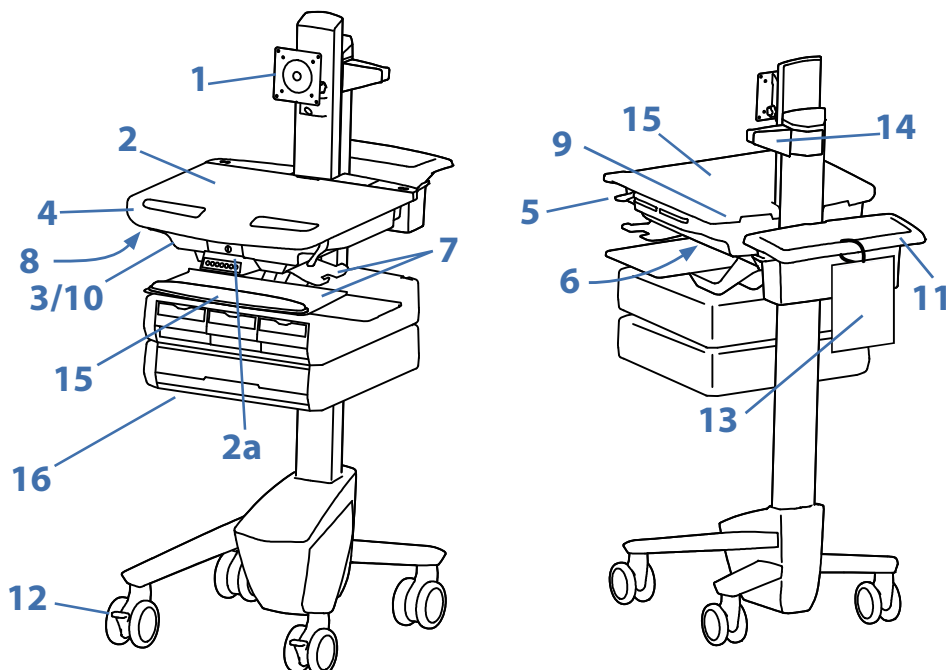

1. Height Adjustable LCD Mount attaches LCDs or tablet PC's with 75x75 or 100x100mm mounting interface
2. Worksurface 2a. Worksurface Lock and Release
3. Secure Storage for Laptop, Thin Client or CPU
4. Front Handle
5. Height Adjustment Brake Handle
6. USB Hub connects keyboard and mouse USB cables
7. Keyboard tray slides out, tilts and allows for right or left mousing with attached mouse holder
8. Keyboard Light under Front Handle
9. Keyboard Light Switch
10. Cable Management and Storage for excess cables and power supplies
11. Storage Basket and Rear Handle
12. Front Locking Casters
13. Quick Reference Card
14. Scanner Holder
15. Antimicrobial worksurface and antimicrobial coating on wrist rest
16. Auto-Lock Drawer (see page 3 for drawer configurations)

Features & Specifications

Part Number	Auto-Lock Drawer
SV43-1310-0	1 Drawer*/16 compartments
SV43-13B0-0	1 Drawer*/9 compartments
SV43-1320-0	2 Drawers*/32 compartments
SV43-13A0-0	2 Drawers*/8 compartments
SV43-13C0-0	2 Drawers*/8 compartments
SV43-1330-0	3 Drawers*/48 compartments
SV43-1340-0	4 Drawers*/28 compartments
SV43-1360-0	6 Drawers*/24 compartments
SV43-1390-0	9 Drawers*/36 compartments

*Auto-Lock Drawer

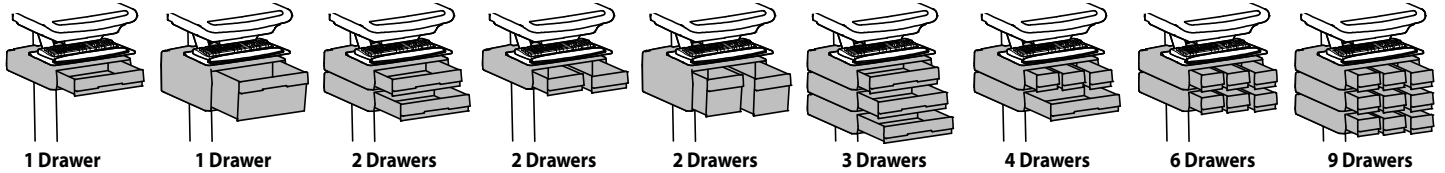

Weight Capacity

0 lbs (0 kg) Open Worksurface
 <5 lbs (2.3 kg) Closed Worksurface
 <13 lbs (5.9 kg) CPU Compartment

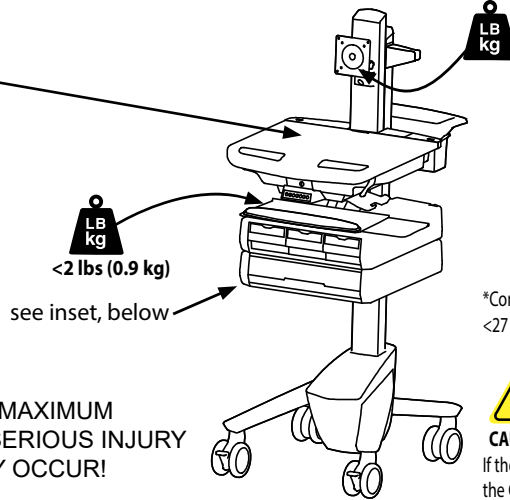

With Independent LCD Lift: <14 lbs (6.4 kg)	Without Independent LCD Lift: 20 lbs (9 kg)* * See "How To Eliminate Independent LCD Lift" section
--	--

*Combined LCD and CPU Compartment weight:
 <27 lbs (12.2 kg).



CAUTION: DO NOT EXCEED MAXIMUM LISTED WEIGHT CAPACITY. SERIOUS INJURY OR PROPERTY DAMAGE MAY OCCUR!



CAUTION: If the combined LCD and CPU weight is greater than 27 lbs (12.2 kg) then the CPU must be mounted to the rear of the cart using the Universal CPU Holder accessory (ordered separately).

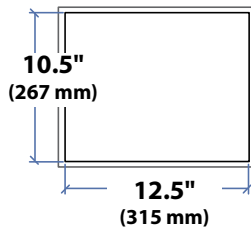
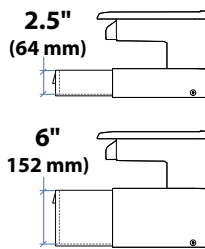
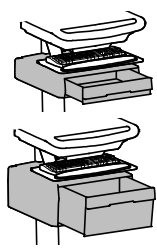

Total weight capacity per drawer.
 ≤ 2 lbs (1 kg)

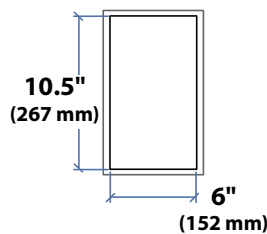
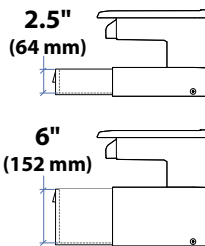
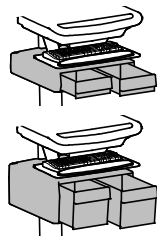
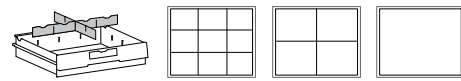

Total weight capacity per drawer.
 ≤ 1 lbs (0.5 kg)

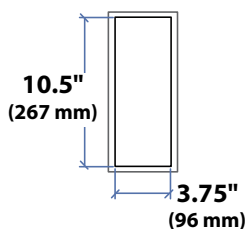
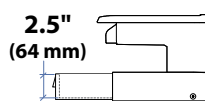
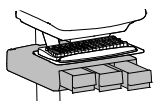
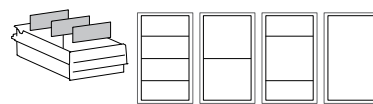

Total weight capacity per drawer.
 ≤ 0.25 lbs (0.1 kg)



Features & Specifications

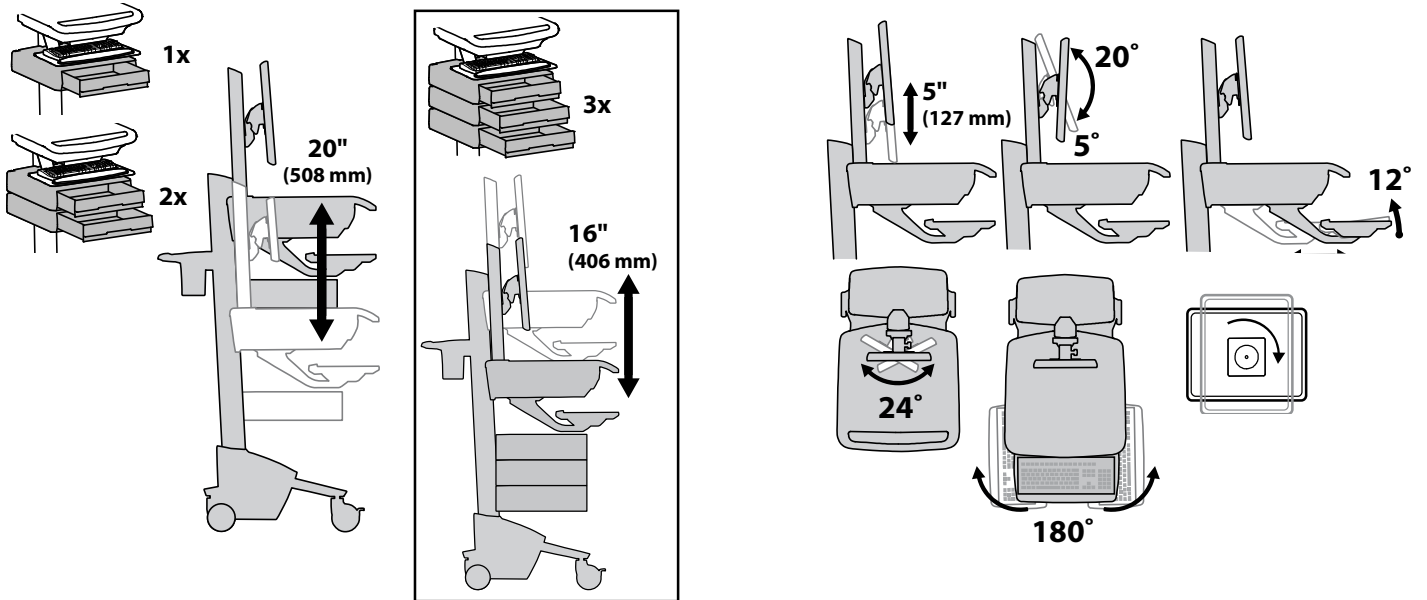

Features & Specifications

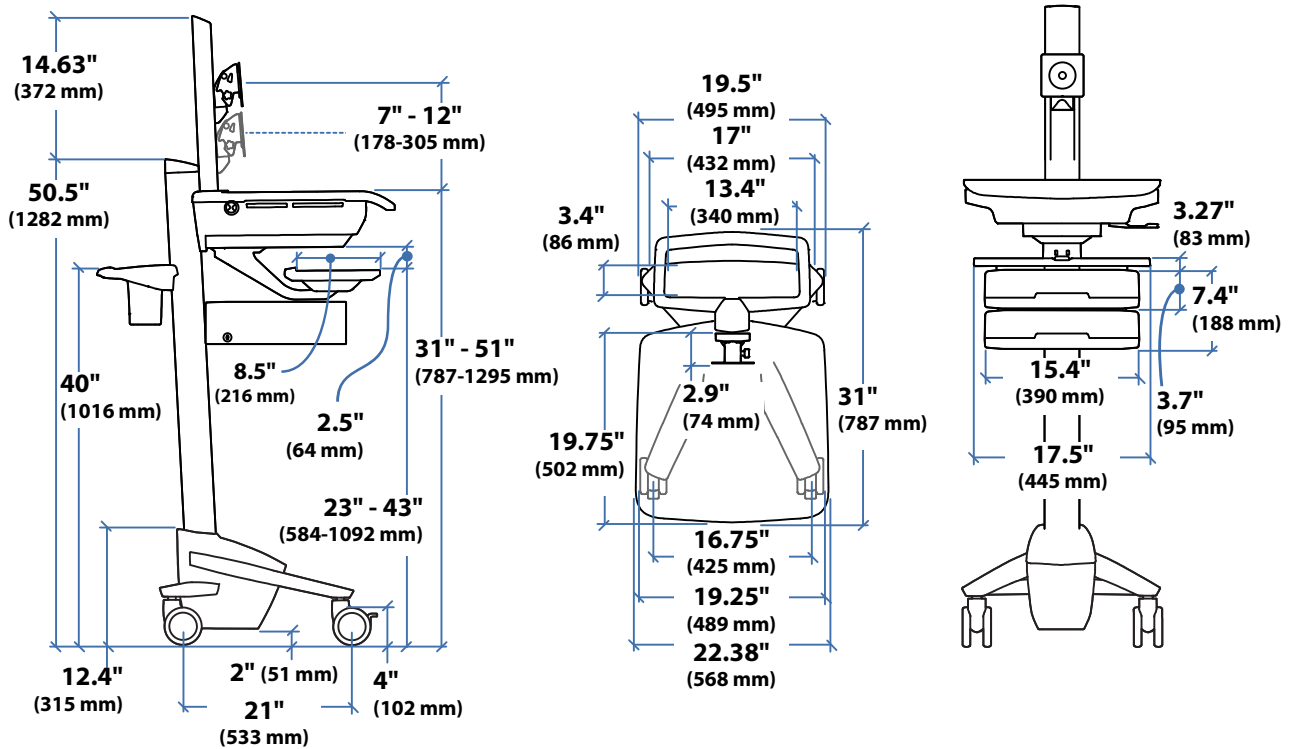

CPU Compartment

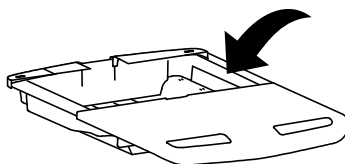

When figuring dimensions, include mounted accessories, protruding cables and port replicators or docking stations.

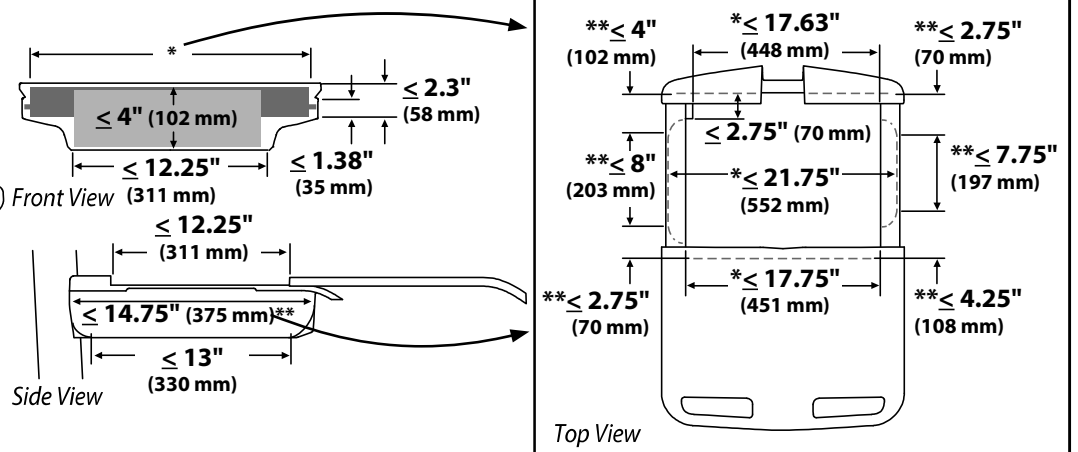

Set-up

1

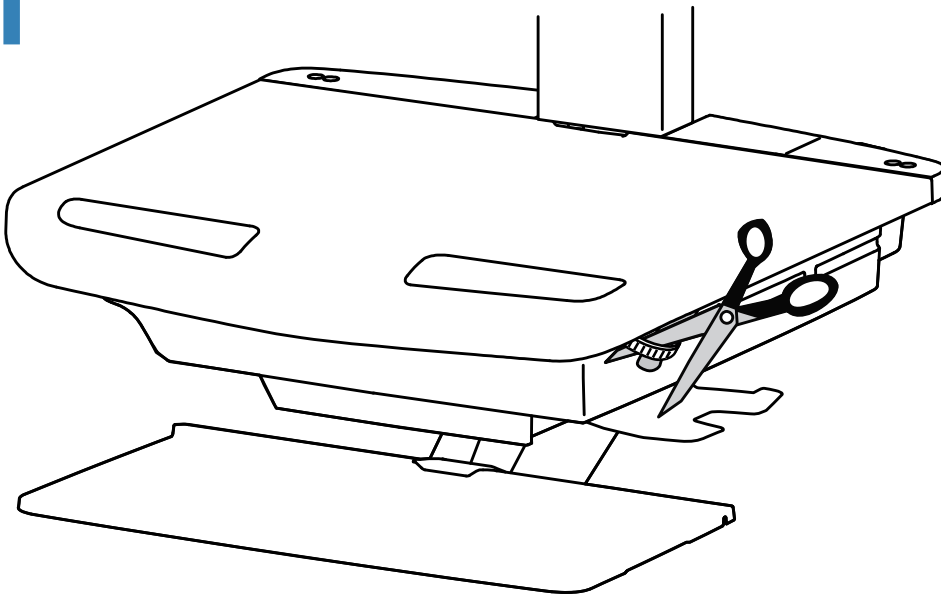

Release Brake to move riser.

CAUTION! Completely release brake engagement before raising or lowering the cart. Raising or lowering the cart with the brake partially engaged may cause product damage.

2 a

40"
(1016 mm)

2x
M3.5 x 6mm

b

1x 1x

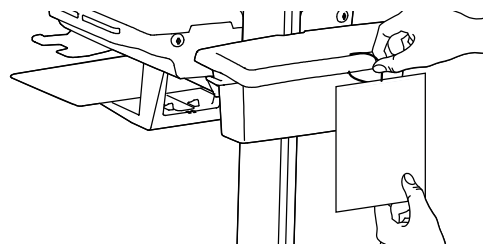

Set-up

3 a

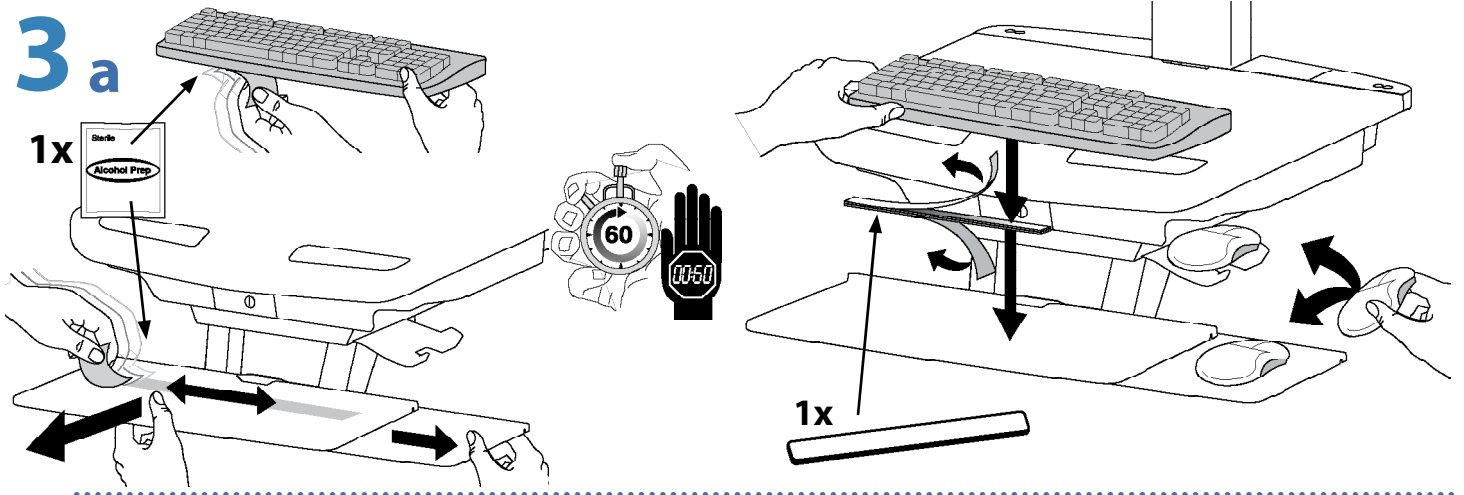

b

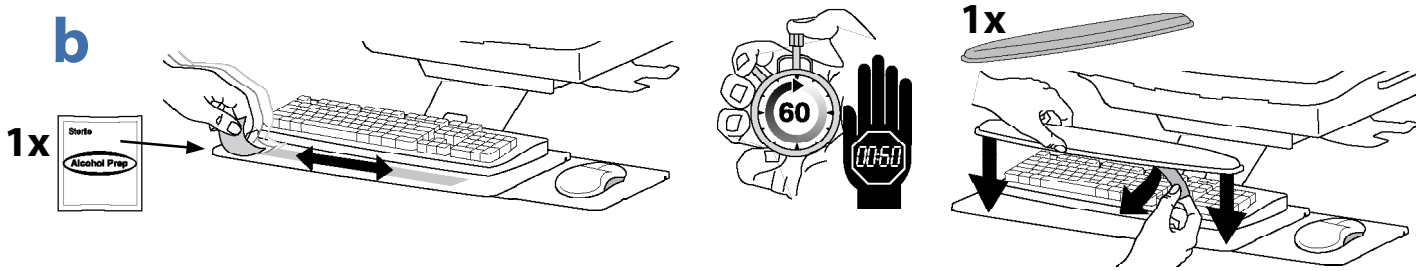

c

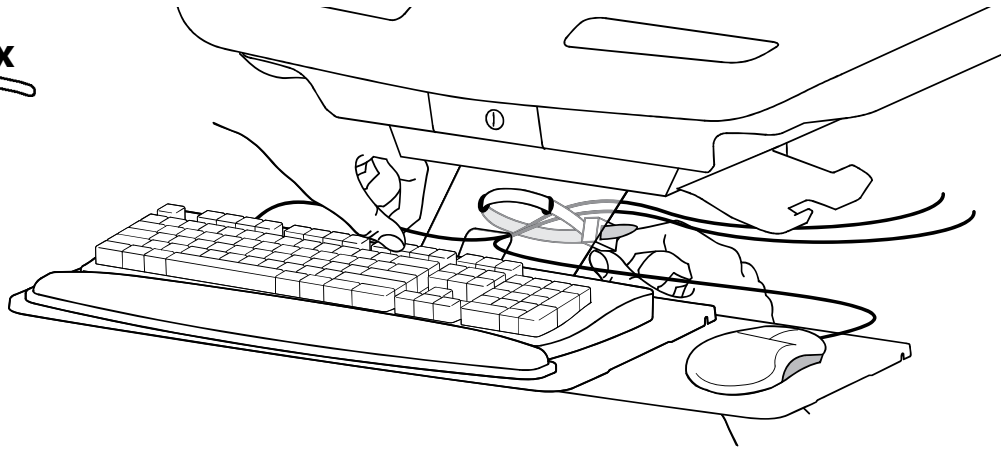
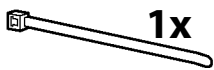

d

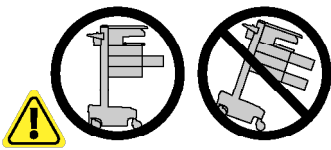

CAUTION: Close worksurface before opening drawers. Open only one drawer at a time. Do Not push cart when drawers or worksurface are open. Failure to follow these instructions may cause the cart to be unstable.

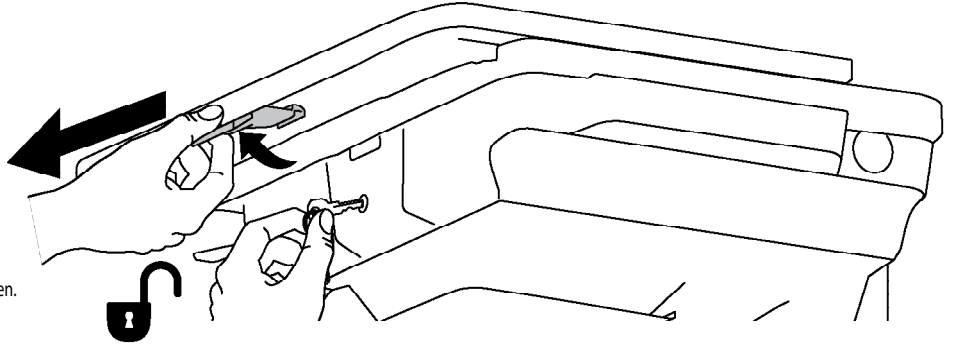

e

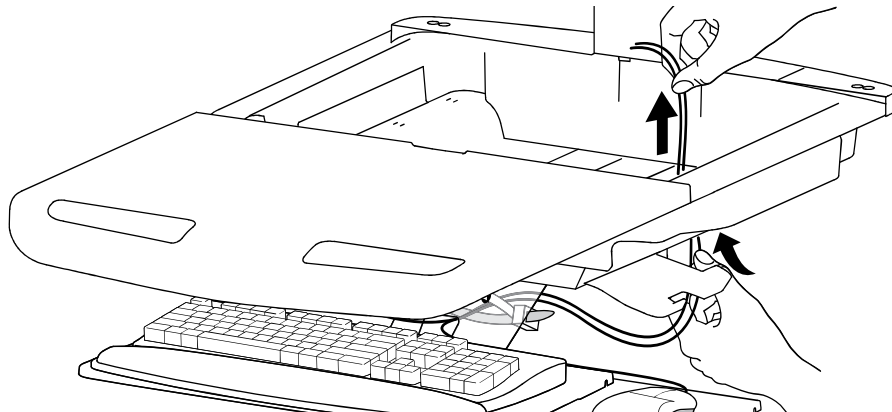

Set-up

4

Connect Keyboard and Mouse to USB Hub

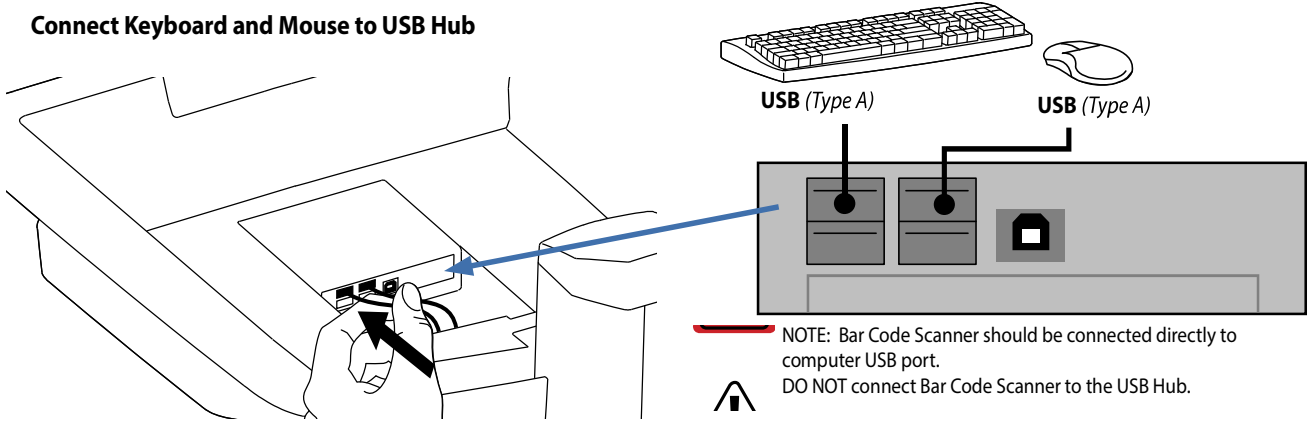

5a

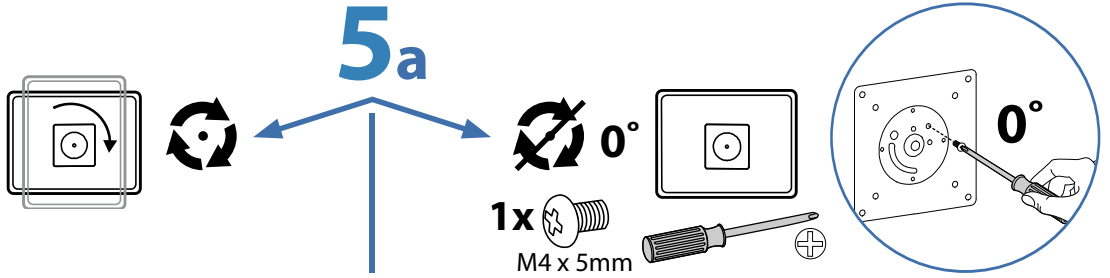

b 75x75mm / 100x100mm

WARNING

Impact Hazard!
 Moving Parts can Crush and Cut.
 Raise monitor to top of vertical adjustment BEFORE removing.
 Failure to heed this warning may result in serious personal injury or property damage!

822-310

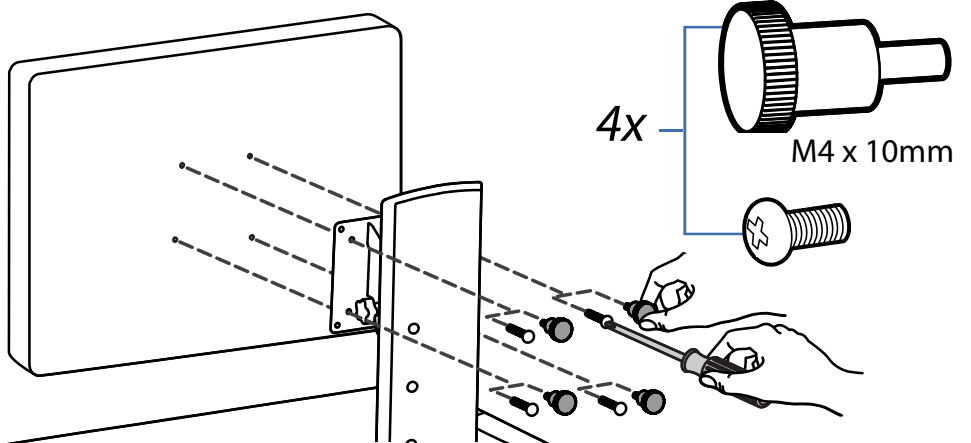

9 Drawers

For 9 drawer carts only:
 After installing the monitor, remove and save the shipping screw.

WARNING AVERTISSEMENT

IMPACT HAZARD!
MOVING PARTS CAN CRUSH AND CUT.
 Failure to heed this warning may result in serious personal injury or property damage!
 Raise monitor to top of vertical adjustment BEFORE removing.
 DO NOT remove Stop Screw without monitor attached. Doing so will cause monitor pivot to shoot up rapidly and may cause personal injury.

DANGER D'IMPACT !
 LES PARTIES EN MOUVEMENT PEUVENT ÉCRASER ET COUPER.
 Il existe un risque de blessure corporelle ou d'endommagement matériel en cas de non respect de cet avertissement.
 Élevez l'écran au plus haut de l'ajustement vertical AVANT de le retirer.
 NE retirez PAS la vis d'arrêt avant que l'écran soit fixé.
 Dans un tel cas, le pivot d'écran se relèverait rapidement et cela pourrait engendrer des blessures.

www.ergotron.com 822-055

Set-up

6

To increase space and improve airflow, power brick may be stored under the storage area.

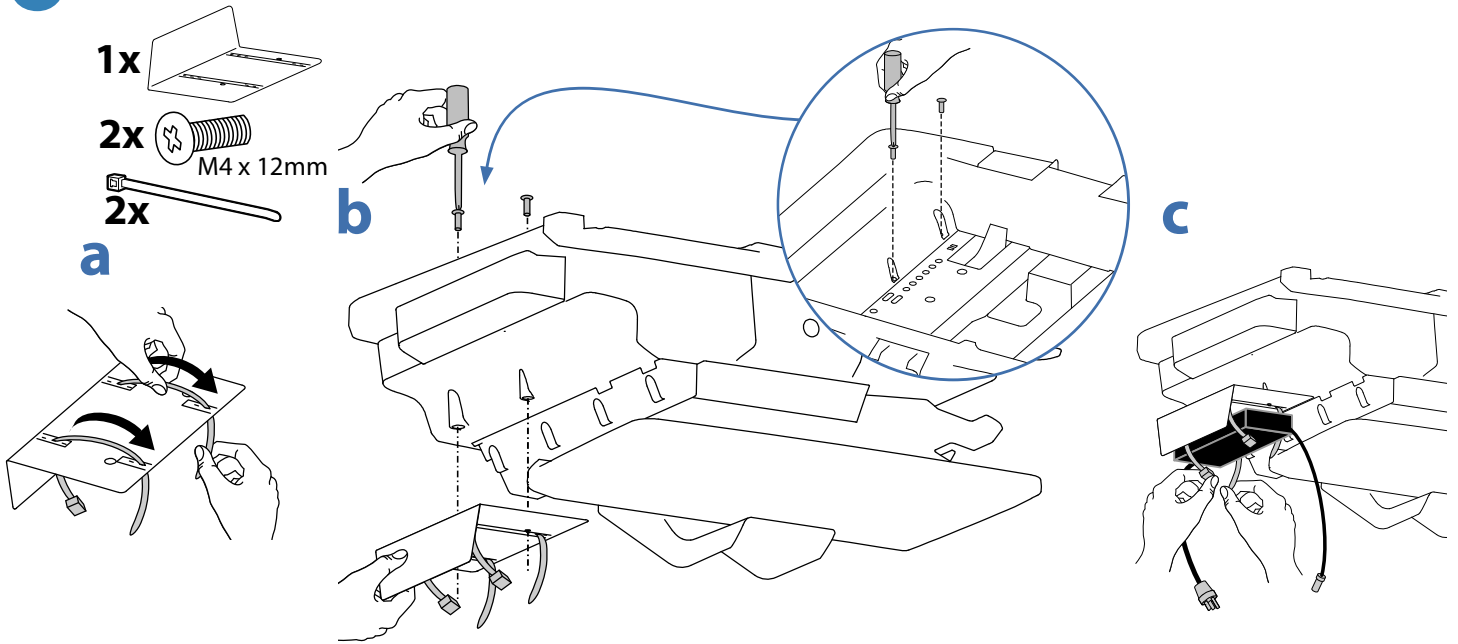

d Route power cable down along tower.

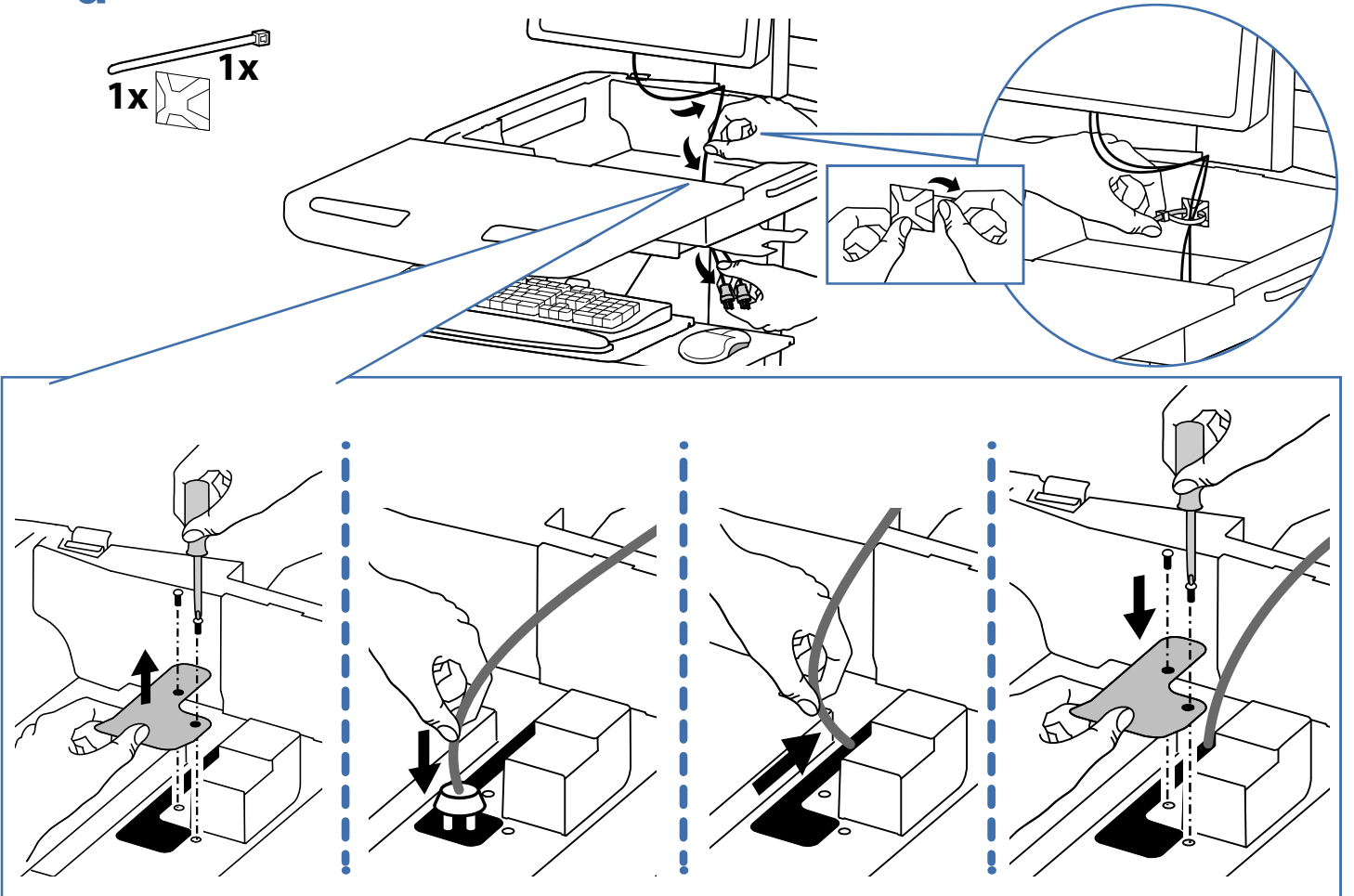

WARNING! DO NOT OPERATE WITHOUT GUARD IN PLACE. Only remove guard when routing a cable with a large connector through the bottom of the compartment. Replace guard immediately after routing cable. Failure to replace guard may result in equipment damage and or personal injury.

7

Place computer and AC power adaptors in compartment. Do not place power bricks near computer or compartment air vents.

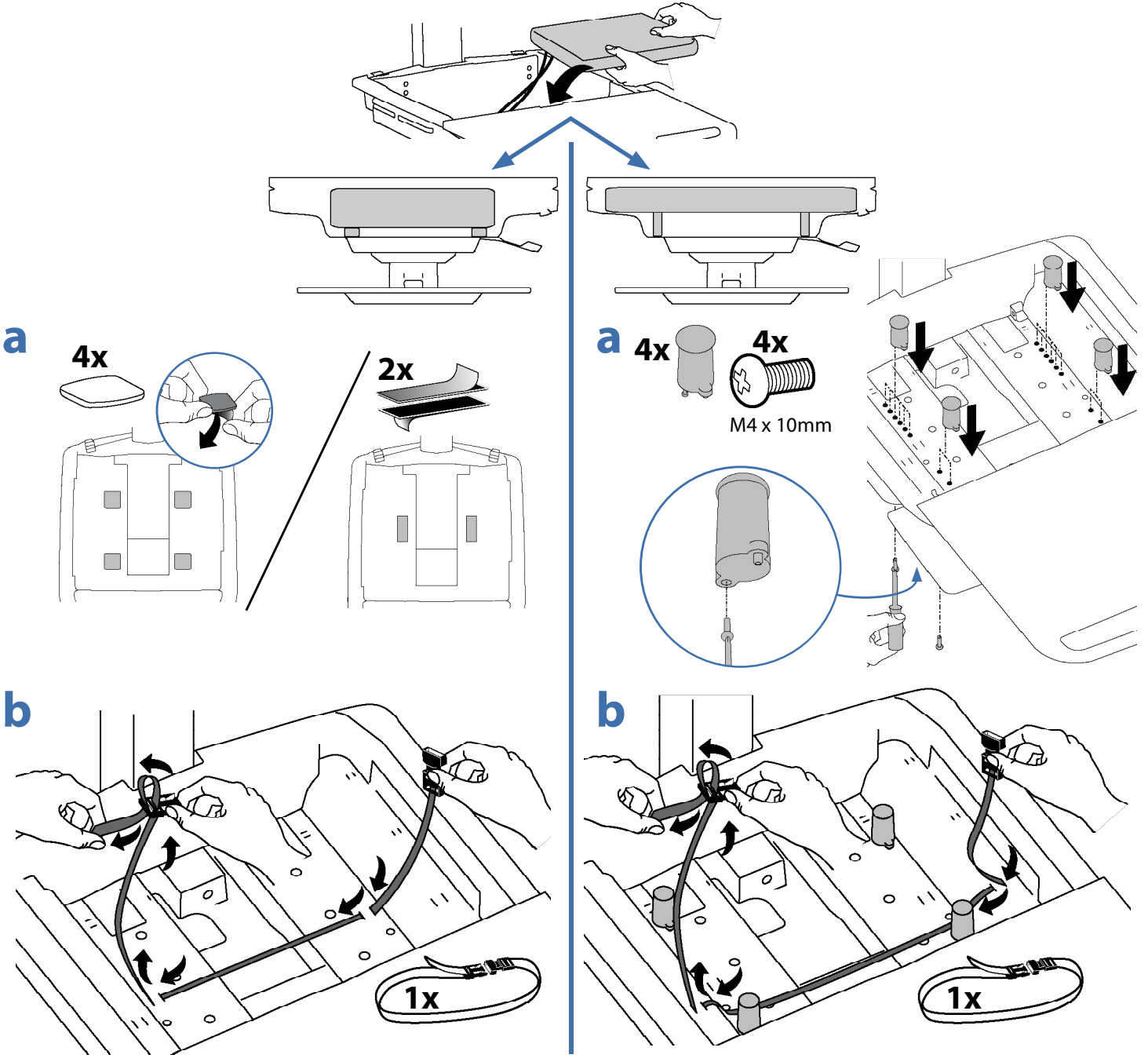

C Plug the following factory connected cables into your computer.
USB: This cable runs from the USB Hub to your computer and uses your computer to power the USB Hub, Keyboard Lights and Fan. (NOTE: Your computer must be turned on for the USB Hub, Keyboard Lights and Fan to function).

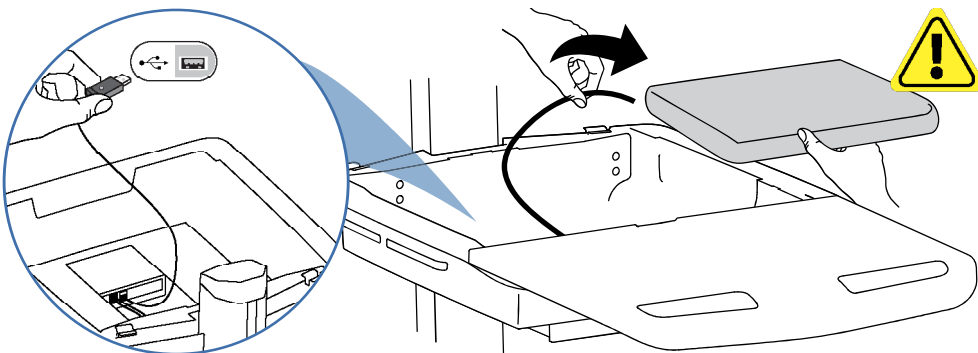

WARNING: Fan must always be running when computer is on. Operating computer without fan may lead to overheating, resulting in reduced equipment performance.

Set-up

d

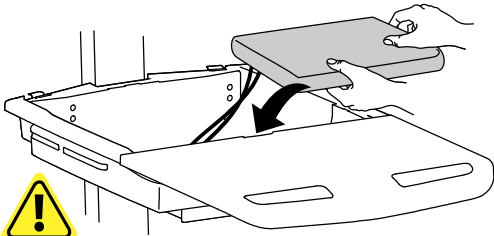

DO NOT OBSTRUCT AIR VENTS!
Obstructing air vents may cause overheating and result in equipment damage.



Placement of CPU's in Secure Storage Area:

USFF (Ultra Small Form Factor)

Thin Client

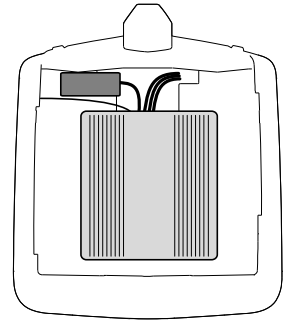
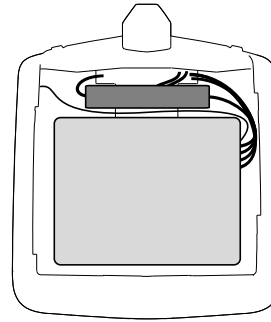

Center CPU in storage area.

To increase space and improve airflow, power brick may be stored under the storage area.

e

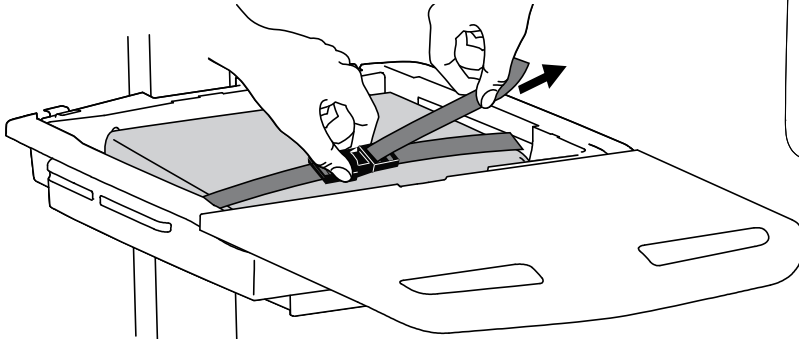

If computer with cables is too wide, then follow these instructions.

1

2

f



1x

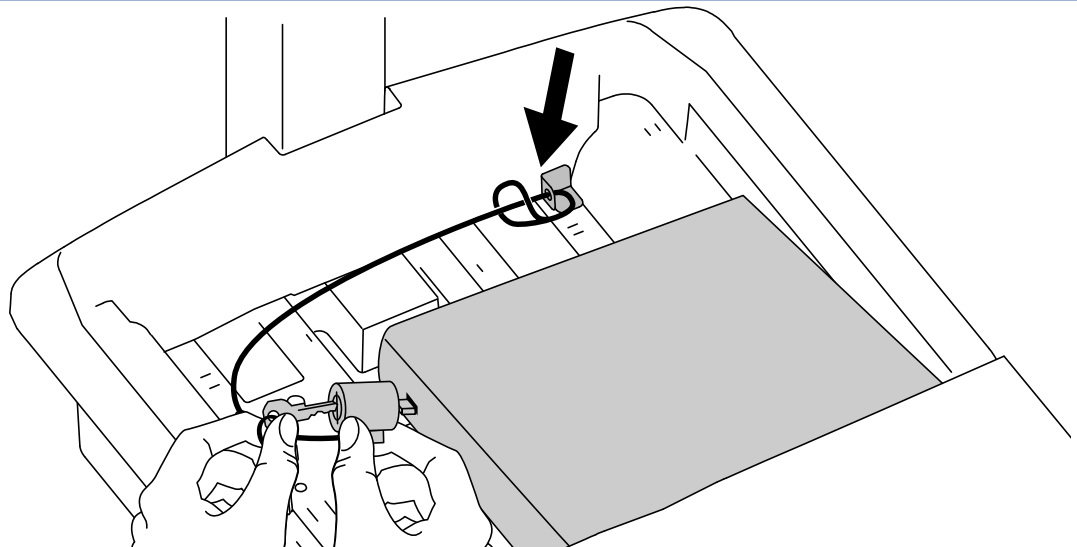

8

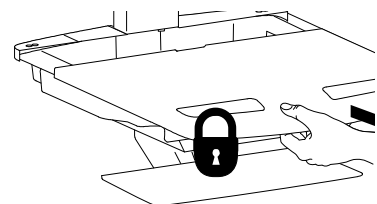
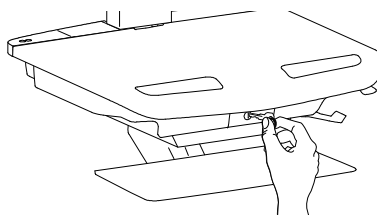
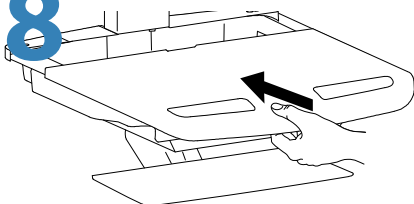

Set-up

9

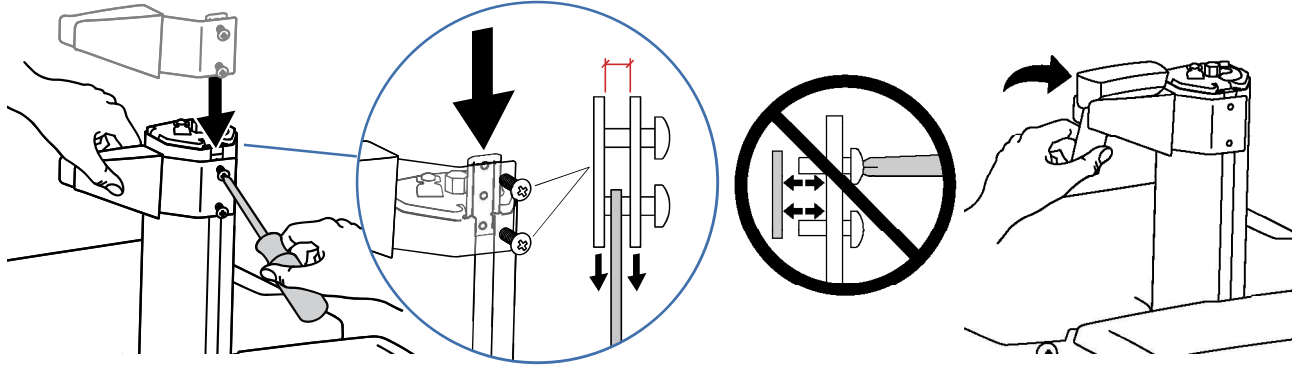

Adjustment

10



It is important that you adjust this product according to the weight of the mounted equipment as described in the following steps. Any time equipment is added or removed from this product, resulting in a change in the weight of the mounted load, you should repeat these adjustment steps to ensure safe and optimum operation.

Adjustments should move smoothly and easily through the full range of motion and stay where you set it. If adjustments are difficult and do not stay in the desired position, follow the instructions to loosen or tighten the tension to create a smooth, easy adjustment motion. Depending on your product and the adjustment, it may take several turns to notice a difference.

a  Release Brake to move riser.

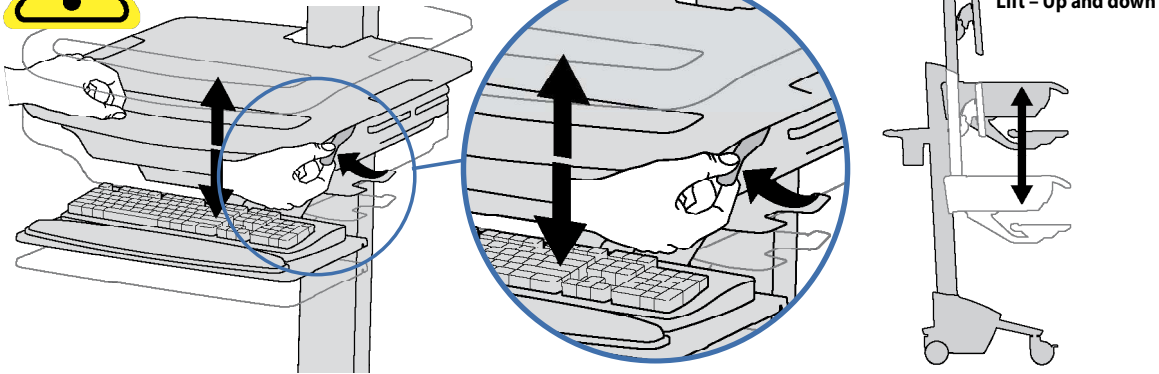

 Follow these instructions to tighten or loosen tension.

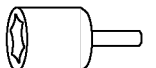
 14mm (9/16")

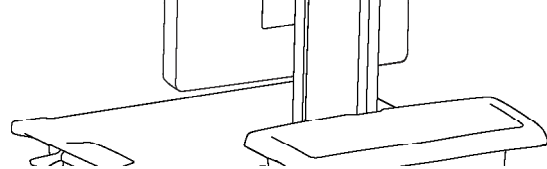

NOTE: Adjustment may require 40 - 60 revolutions.

1x  M4 x 8mm

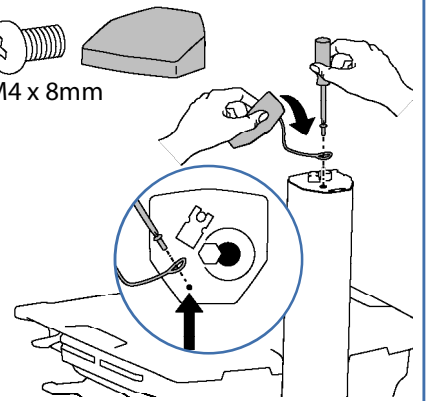

b Tilt - Forward and Backward

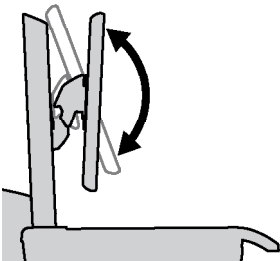

Loosen knob, tilt Display to desired position then retighten knob.

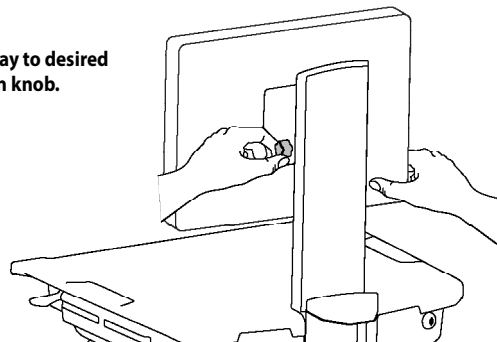

Adjustment

c Lift - Up and down

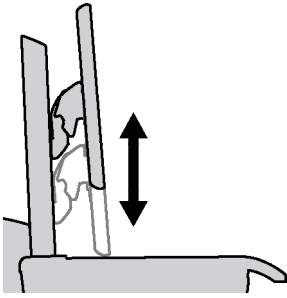

Follow these instructions to tighten or loosen tension.

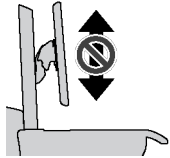
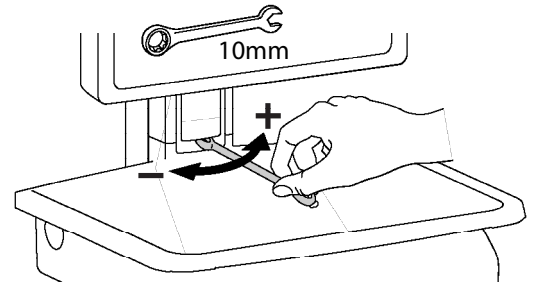
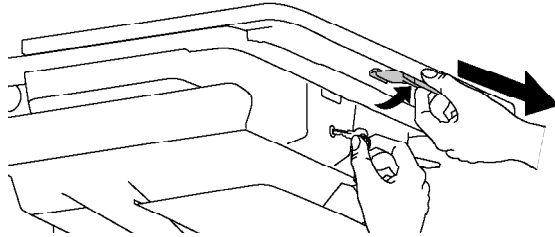
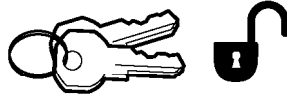

To Stop Independent LCD Lift

For heavier Displays or when using a Tablet PC, you can keep the LCD Lift from moving out of position, by installing this screw into one of the three holes on the back of the riser depending on the desired height.

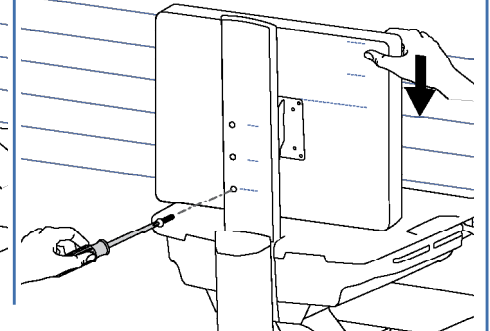
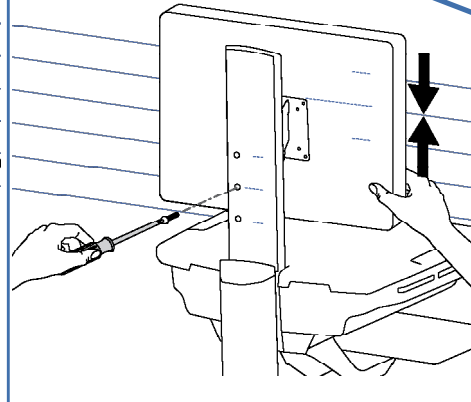
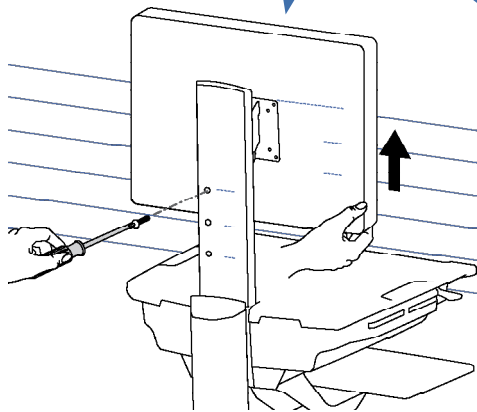
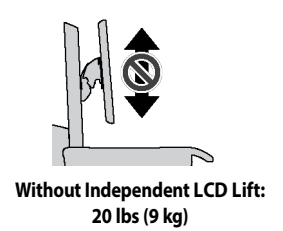
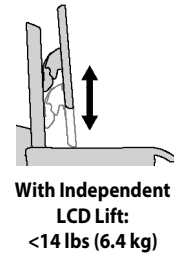
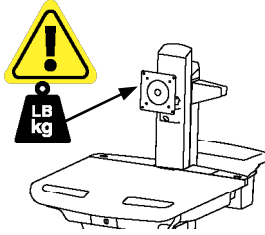
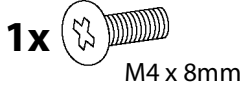

WARNING
AVERTISSEMENT

- 1.
- 2.
- 3.

IMPACT HAZARD!
MOVING PARTS CAN CRUSH AND CUT.
Failure to heed this warning may result in serious personal injury or property damage!
Raise monitor to top of vertical adjustment BEFORE removing. DO NOT remove Stop Screw without monitor attached. Doing so will cause monitor pivot to shoot up rapidly and may cause personal injury.

DANGER D'IMPACT !
LES PARTIES EN MOUVEMENT PEUVENT ÉCRASER ET COUPER.
Il existe un risque de blessure corporelle ou d'endommagement matériel en cas de non respect de cet avertissement.
Élevez l'écran au plus haut de l'ajustement vertical AVANT de le retirer. NE retirez PAS la vis d'arrêt avant que l'écran soit fixé.
Dans un tel cas, le pivot d'écran se relèverait rapidement et cela pourrait engendrer des blessures.

www.ergotron.com

822-055

d Pan - Side-to-Side

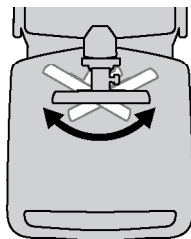

Follow these instructions to tighten or loosen tension.

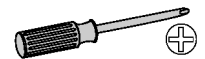
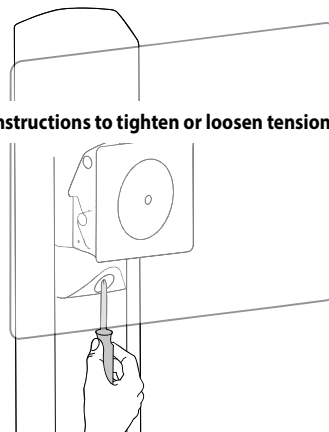

Auto-Lock Drawer

11

AutoLock Drawer Battery Pack

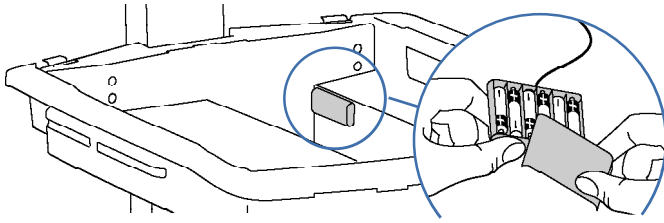

Batteries may not come fully charged and may need to charge for several hours. To charge ALD batteries computer needs to be powered on and connected to the USB hub.

6x AA Rechargeable Nickel Metal Hydride



WARNING! Only use NiMh rechargeable batteries. Using any other types of batteries may cause them to leak, rupture, or explode causing personal injury or equipment damage.

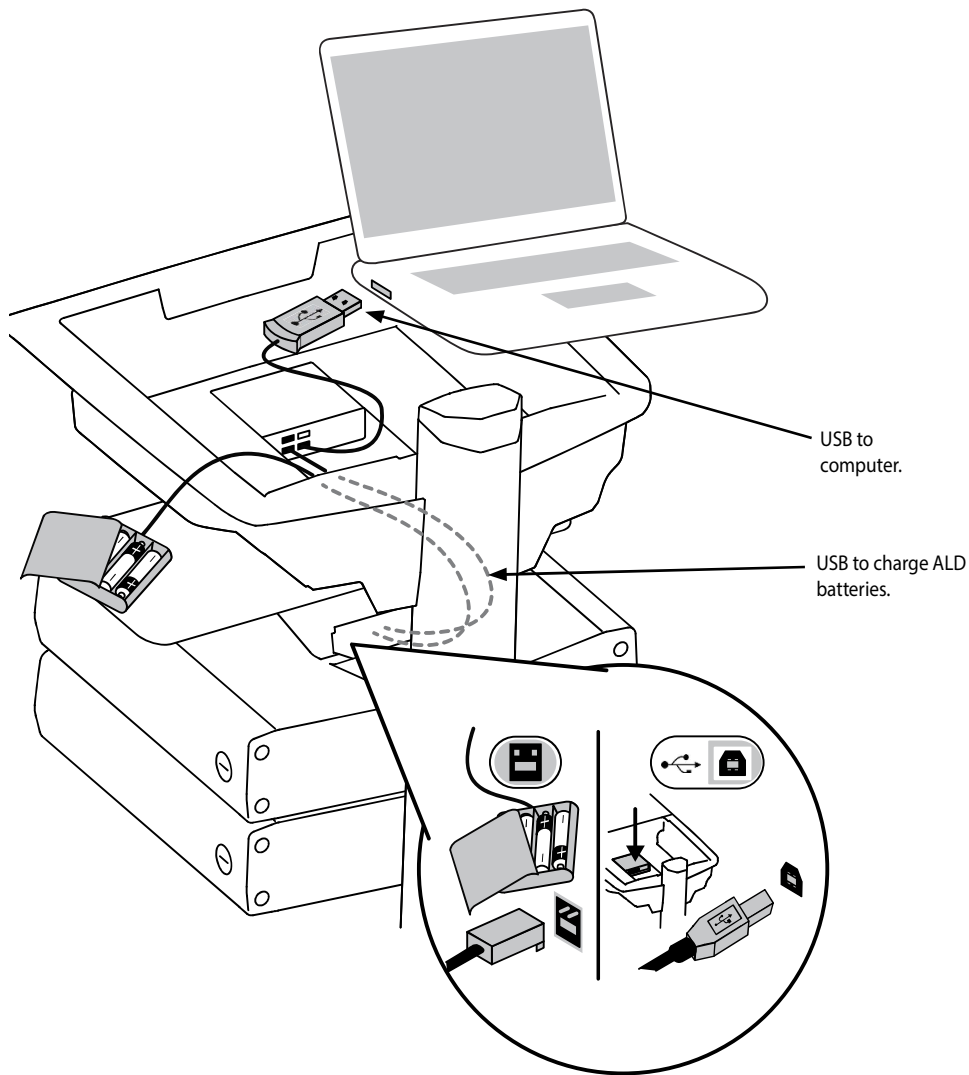

Auto-Lock Drawer

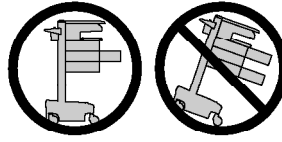
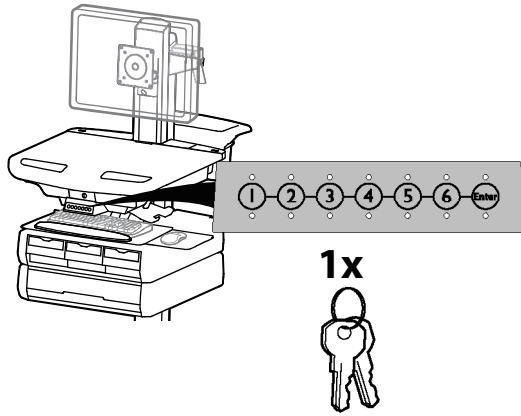

CAUTION: Open only one drawer at a time. Do Not push cart when drawers are open. Failure to follow these instructions may cause the cart to be unstable.

NOTE: Change Master Personal Identification Number (PIN) upon receipt of cart. A User PIN must be created to open drawers electronically.

Ensure that the main power system batteries are installed and functioning. The power does not need to be turned on at the power system user interface.

User PINs:

- Carts store up to 1,000 PINs.

Without StyleLink management:

- PINs entered on the cart and not managed by StyleLink may vary in length from 4-7 digits.

- Ergotron recommends the following for choosing PIN digit length (assumes less than 1 in 25 chance of guessing random User PIN):

Max number of User PINs >50, 5+digit length recommended

Max number of User PINs >300, 6+digit length recommended

For maximum security use PIN length of 7

With StyleLink management:

- 5 digit PIN length required.

Set-up Master PIN for the First Time (Default Master PIN: 12345)

Contact Ergotron Customer Care for instructions if Master PIN is lost.

1. Enter default Master PIN (1-2-3-4-5) then press ENTER.
2. Press 5 for Master PIN change mode
3. Enter new Master PIN and press Enter (LEDs will blink green if PIN is accepted)
4. Master PIN entry mode will exit after 5 seconds of inactivity (LEDs blink red twice)

Master PIN Mode Menu (NOTE: Master PIN does not open drawers.)

Enter Master PIN and then select one of the below numbers to enter that mode

1. After entering Master PIN, Select 1 to access User PIN Entry Mode
2. After entering Master PIN, Select 2 to access Pharmacy PIN Entry/Change Mode
5. After entering Master PIN, Select 5 to access Master Pin Change Mode
- 6, 1. After entering master PIN, select 6 then select 1 to disable alarm. Repeat process to enable alarm.
- 6, 2. After entering master PIN, select 6 then select 2 to enable bulk unlock mode. This will cause all drawers to open when any user PIN is entered. Repeat process to revert back to default.
- 6, 6, Master PIN, Enter. After entering master PIN, select 6 then select 6 again, then enter Master PIN again, then select Enter. This will reset keypad to the factory default Master PIN as 1, 2, 3, 4, 5, and will also delete all User PINs and Pharmacy PIN.

Lost Master PIN

Contact Ergotron Customer Care for instructions.

Programming User PINs

1. Enter Master PIN and press ENTER for Mode Menu.
2. Press 1 for User PIN Entry Mode.
3. Input new User PIN and press ENTER (All LEDs blink green if PIN is accepted). You may enter multiple USER PINs consecutively.
4. User PIN entry mode will exit after 5 seconds of inactivity (LEDs blink red twice).

NOTE: User PIN cannot be the same as a Master PIN or Pharmacy PIN. Once maximum User PIN storage is exceeded, the oldest User PIN will be over written.

Programming Pharmacy PIN

1. Enter Master PIN and press ENTER for Mode Menu
2. Press 2 for Pharmacy PIN Entry Mode
3. Input Pharmacy PIN and press ENTER (all LEDs blink green in PIN is accepted).
4. Pharmacy PIN entry mode will exit after 5 seconds of inactivity (LEDs blink red twice).

Note: System will hold 1 Pharmacy PIN. Pharmacy PIN allows all drawers to unlock at the same time. Drawers should then be opened at least slightly as the system will auto-lock after 15 seconds. All LEDs will flash green until system auto-locks. Once a drawer is opened the corresponding LED for that row will light solid until it is placed back into its original location.

If drawers are removed from cart for filling, they must be replaced in the same configuration per row. If they are not, power must be removed and reapplied so that the drawer system reconfigures itself.

Auto-Lock Drawer

Unlock Drawer (2 methods): NOTE: All Drawers in row must be closed before a new row can be unlocked.

- Enter User PIN and press ENTER (only numbers for available drawer rows flash green), then press desired drawer row number*.
- Key

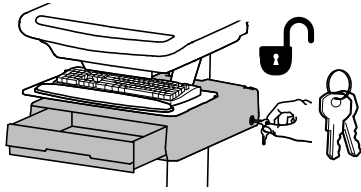
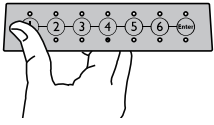

*Drawer Row Numbers:

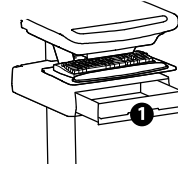

Lock Drawer:

- Wait 4 seconds for lock to engage automatically.
- NOTE: Always ensure drawer is pushed in all the way and engaged with lock.

Drawer Troubleshooting

- No LEDs on keypad when pressing any number:
 - Verify DC cable is connected from cart battery harness to controller.
 - Verify keypad cable is connected to controller.
 - Verify circuit breakers are not tripped and 5A fuse is installed in battery harness.
- Drawer selection not available when User PIN is entered:
 - Check to make sure drawer cable is installed securely.
 - Remove power from drawer system for 10 seconds and re-apply.
- LEDs flash red/green after User PIN is entered:
 - Battery charge is low, check to make sure USB charging cable is plugged into computer and computer is ON.

LEDs/Alarm Meaning:

1,2,3,4, or 5 LED ON green: Corresponding Drawer is open.

1,2,3,4, or 5 LED flashing red and alarm sounding: Corresponding Drawer is open longer than 20 seconds. Mute alarm by pressing flashing button corresponding to open drawer.

All available drawer numbers flashing green: Waiting for drawer selection (see Unlock Drawer).

All LEDs blink red twice: PIN entry rejected/exit current mode after 5 seconds timeout.

All LEDs blink green 3 times: PIN entry accepted.

All LEDs flashing red: No drawers connected to controller, check cable.

All LEDs flashing red/green: System power ON or low battery condition.

One or more LEDs flashing red 8 times: Invalid drawer configuration for corresponding drawer row(s). Verify drawers are installed correctly and remove and reapply power.

Set-up

12

Keyboard Light

1. Turn Computer on.
 2. Test Keyboard Light.
- Keyboard Light will automatically turn off after 15 minutes if not manually turned off.

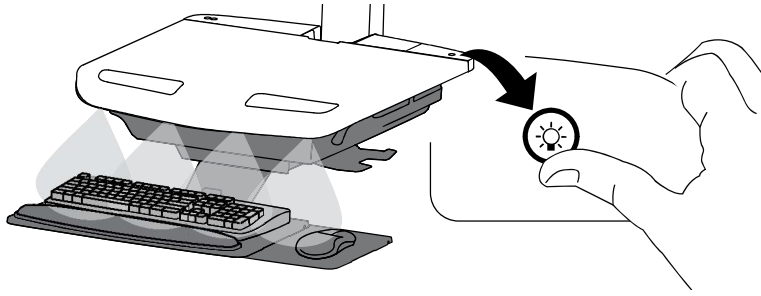

Ergonomics

Working

customize - to your size

- 1 Set top of monitor screen about one inch below eye level - Release brake and lift or lower riser as needed.
- 2 Tilt screen for comfortable viewing and to reduce eye and neck strain.
- 3 Pull keyboard tray forward and position mouse tray on right or left, as needed.
- 4 Work with elbows bent at about 90° to minimize muscle strain.
- 5 If the riser moves up and down with difficulty, or if it drifts out of set position, consult the product manual for adjustment information.
- 6 Stay in charge!
Powered carts should be plugged into outlet as often as possible to keep battery charged and computer running.

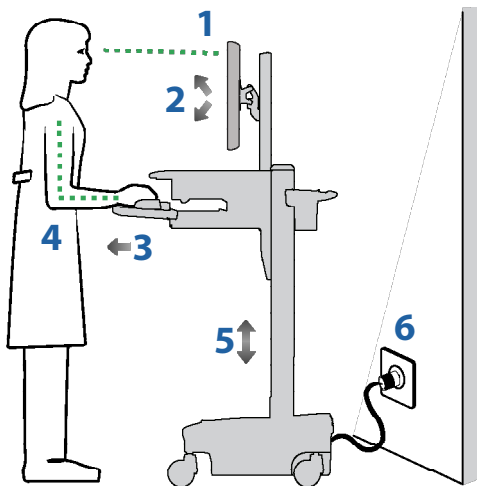

Moving

stow - before you go

- 1 During normal movement, release brake and lower worksurface to lowest position for optimal stability and unobstructed view.
- 2 Tuck away open trays and return mouse, scanner and other accessories to their places. Clear worksurface
- 3 Unlock both front casters.
- 4 Push cart from rear with elbows bent at about 90° to maximize control and minimize muscle strain.
- 5 Don't run out!
Before moving, make sure cord is unplugged from outlet and hooked to basket for safe travel. Remember, charge battery fully 100% every day!

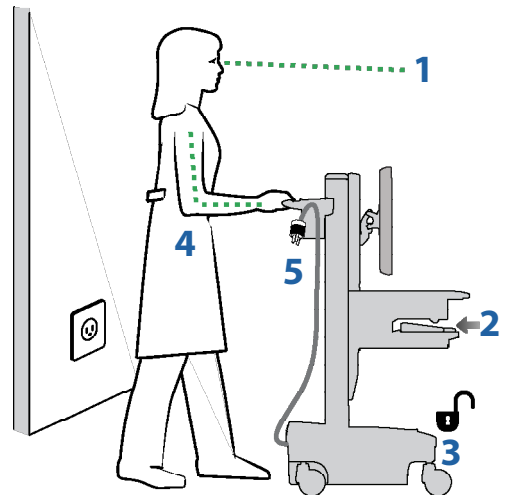

Maintenance & Safety

Hazard Symbols Review

The Meaning of Symbols appearing in this Guide, on the Cart or on the Power System

These symbols alert you to a safety condition that demands your attention. You should be able to recognize and understand the significance of the following Safety Hazards if you encounter them on the Cart or within Cart documentation such as this Set-up Guide.



EQUIPMENT & ACCESSORIES DISPOSAL

1. Please dispose of all batteries in accordance with local law
2. All Electronics should be recycled through an electronics recycler.
3. Remaining plastics and metals can be recycled through a commercial recycler.

Symbol	Signal Word/ Color	Level of Hazard
	DANGER	Indicates an imminently hazardous situation which, if not avoided, will result in death or serious injury.
	WARNING	Indicates a potentially hazardous situation which, if not avoided, could result in death or serious injury.
	CAUTION	Indicates a potentially hazardous situation which, if not avoided, may result in minor or moderate injury.
	CAUTION	Used without the safety alert symbol indicates a potentially hazardous situation which, if not avoided, may result in property damage.
	INSTRUCTIONS	Follow operating instructions.
	INSTRUCTIONS	Follow operating instructions.
	POWER	"ON" / "OFF" (push-push) NOTE: Each position "ON" / "OFF" is a stable position.



Cleaning and Maintenance

The following procedures are not guaranteed to control infection. The hospital infection control administrator or epidemiologist should be consulted regarding cleaning procedures and processes.

To avoid risk of electric shock, do not expose electrical components to water, cleaning solutions or other potentially corrosive liquids or substances.

Do not immerse Cart or Cart components in liquid or allow liquids to flow into the Cart. Wipe all cleaners off surface immediately using a damp cloth. Thoroughly dry surface after cleaning.

Do not use flammable cleaners on Cart surfaces due to close proximity of electrical power and equipment.

All paints and plastic Cart components will withstand cleaning by most commonly used, diluted, non-abrasive solutions such as quaternary ammonia compounds, ammonia enzyme cleaners, bleach or alcohol solutions.

- Pen and permanent and dry erase markers can be removed with 91% isopropyl alcohol and a soft cloth.
 - Iodine stains can be removed with commonly used cleaners and a soft cloth.
 - Never use steel wool or other abrasive materials that will damage the surface finish.
 - Do not use strong solvents such as trichloroethylene and acetone. These solvents will damage the surface finish.
- It is recommended that any cleaning solution be tested on a small, inconspicuous area to ensure surface is not harmed.

Adjustment, Service, Replacement - DO NOT attempt to adjust, service or replace any part of the StyleView Cart unless directed to do so through Ergotron-approved documentation (i.e. installation instructions). Only Ergotron, Inc. or an Ergotron-certified entity may adjust, service or replace StyleView Cart components. If any component on the Cart is missing or damaged, the Cart must not be used, contact Ergotron Customer Care immediately to request a replacement part.

Cables - Keep cables neatly organized on the Cart (a variety of solutions are provided with your cart for this purpose). Excess cables should be routed away from moving components with cable clips. Review Cable Routing section of this guide, or contact Ergotron Customer Care for more information.

Casters - Check casters periodically to make sure they are clean and free of debris that would prevent smooth travel. Avoid moving Cart across uneven, dirty or damaged surfaces.

Customer Equipment- Make sure equipment is balanced and mounted securely to Cart. Do not reposition Cart components on riser or tower unless instructed to do so in the installation instructions. Moving Cart components too high or too low on the Riser may create an unstable condition, leading to equipment damage or even personal injury. Contact Ergotron Customer Care for information about moving Cart components.

Maintenance & Safety



Safety Alerts Associated with this Product

The following Warnings/Cautions appear in this reference guide or on the cart:

NOTE: Failure to adhere to these guidelines may result in equipment damage or personal injury.

CAUTION: The lift brake helps stabilize the worksurface and keyboard tray during normal use but it DOES NOT increase load capacity. DO NOT load riser with equipment totaling more than the maximum weight capacity specified by Ergotron. Ensure optimum lift function by testing and if necessary, re-adjusting tension whenever the weight mounted to the riser changes (i.e., equipment is removed or added). See "Set Riser Lift Tension" adjustment instructions.

CAUTION: Do not operate StyleView Cart with missing or damaged components! Do not remove, modify or substitute Cart components without consulting Ergotron. If you encounter problems with Cart installation or operation, contact Ergotron Customer Care.

CAUTION: DO NOT overtighten fasteners. Overtightening may cause damage to your equipment.

WARNING: Stored Energy Hazard: The worksurface lift mechanism is under tension and will move up rapidly, on its own, as soon as attached equipment is removed. For this reason, DO NOT remove equipment unless the worksurface has been moved to the highest position on the tower! Failure to follow this instruction may result in serious personal injury and/or equipment damage! When Shipping the cart, set the worksurface lift mechanism to the lowest tension setting.

CAUTION: DO NOT loosen, tighten or remove any other nuts or bolts on the riser or top of tower. Tampering with nuts or bolts may result in an unstable Cart, leading to equipment damage and/or personal injury.

CAUTION: Release Lift Brake before moving work surface! Moving work surface while Lift Brake is engaged may cause serious damage to Lift Engine.

WARNING: In the event that repair of the StyleView Cart is needed, contact Ergotron Customer Care immediately. Cart repair can only be performed by Ergotron, Inc. or by an Ergotron authorized agent.

WARNING: This cart is not intended for use in a flammable, anesthetic mixture or oxygen rich environment.



Configuration & Safety

Additional multiple socket-outlet or extension cord shall not be connected to the medical system.

When used in a Medical Electrical system, connect only equipment that complies with IEC, ISO, UL/ANSI, or CSA standards that are relevant to that equipment.

Risk of shock or personal injury when connecting non-medical equipment supplied as part of a system directly to the wall outlet when non-medical equipment is intended to be supplied by the multiple socket outlet.

Risk of shock or personal injury when connecting any equipment that has not been supplied as part of the medical system to the multiple socket outlet.

Recommended Periodic Inspection and Maintenance			
Component	Action	How often	By whom
UI, Ethernet, USB cables	Inspect for wear, pinching, bad connectors	Monthly	Any user
Fan on side of CPU compartment	Inspect for dust at intake, vacuum as required using a vacuum cleaner that DOES NOT generate ESD (Electrostatic Discharge)	Monthly	Any user
Casters	Inspect for wear and debris	Monthly	Any user
Maximum Load	Inspect to ensure that maximum recommended loads are not exceeded	Daily	Any user

1. Please dispose of all batteries in accordance with local law
2. Always replace with similar size battery (33 A-h to replace 33 A-h) and always replace in pairs

For Warranty visit: www.ergotron.com/warranty

For Service visit: www.ergotron.com

For local customer care phone numbers visit: <http://contact.ergotron.com>

ergotron[®]

www.ergotron.com | USA: 1-800-888-8458 | Europe: +31 (0)33-45 45 600 | China: 400-120-3051 | Japan: japansupport@ergotron.com

© 2015 Ergotron, Inc. All rights reserved.