

RANGE OF MOTION

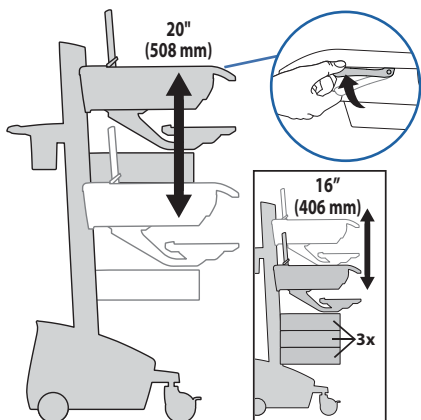

CAUTION! Completely release brake engagement before raising or lowering the cart. Raising or lowering the cart with the brake partially engaged may cause product damage.



KEYBOARD LIGHT

Your computer must be on for this light to function. Keyboard Light will automatically turn off after 15 minutes if not manually turned off.

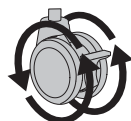
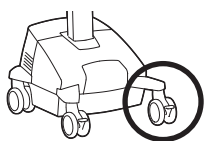
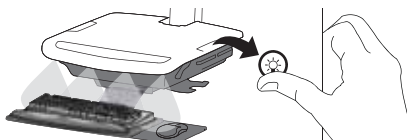

Wheel Rotation

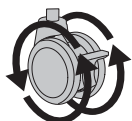

Wheel Rotation and Swivel

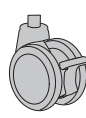
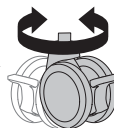

Locked

ERGONOMICS

Working - customize to your size

- 1 Set top of monitor screen about one inch below eye level - Release brake and lift or lower riser as needed.
- 2 Tilt screen for comfortable viewing and to reduce eye and neck strain.
- 3 Pull keyboard tray forward and position mouse tray and mouse pouch on right or left, as needed.
- 4 Work with elbows bent at about 90° to minimize muscle strain.
- 5 If the riser moves up and down with difficulty, or if it drifts out of set position, consult the product manual for adjustment information.
- 6 Stay in charge!
Powered carts should be plugged into outlet as often as possible to keep battery charged and computer running.

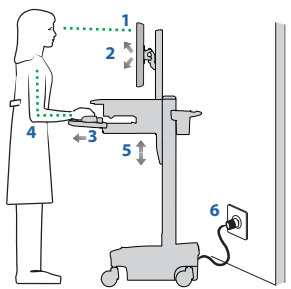

Moving - stow before you go

- 1 During normal movement, release brake and lower worksurface to lowest position for optimal stability and unobstructed view.
- 2 Tuck away open trays and return mouse, scanner and other accessories to their places. Clear worksurface
- 3 Unlock both front casters.
- 4 Push cart from rear with elbows bent at about 90° to maximize control and minimize muscle strain.
- 5 Don't run out!
Before moving, make sure cord is unplugged from outlet and hooked to basket for safe travel. Remember, charge battery fully 100% every day!

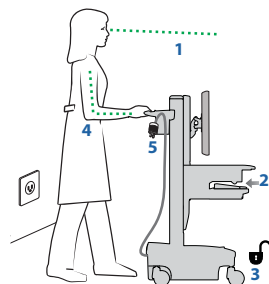

STYLEVIEW® QUICK REFERENCE

ergotron®

www.ergotron.com

USA: 1-800-888-8458

Europe: +31 (0)33-45 45 600

China: 400-120-3051

Japan: japansupport@ergotron.com

Unlock Drawer (2 methods): NOTE: All Drawers in row must be closed before a new row can be unlocked.

- Enter User PIN and press ENTER (only numbers for available drawer rows flash green), then press desired drawer row number*.
- Key

***Drawer Row Numbers:**

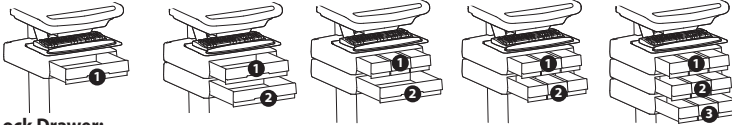

Lock Drawer:

- Wait 4 seconds for lock to engage automatically.

NOTE: Always ensure drawer is pushed in all the way and engaged with lock.

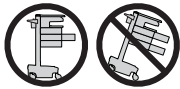
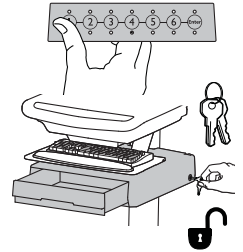

CAUTION: Open only one drawer at a time. Do Not push cart when drawers are open. Failure to follow these instructions may cause the cart to be unstable.

This power system interface will alert you to the percentage of charge remaining in the cart battery with a series of steady or flashing red, yellow or green lights, and an alarm that will beep when charge gets below 10%. Remember, the battery needs to be charged to 100% every day, and you can use the cart while charging, so plug-in cord as often as possible to avoid running out of power!
NOTE: Put monitor in power save mode to optimize battery run time.

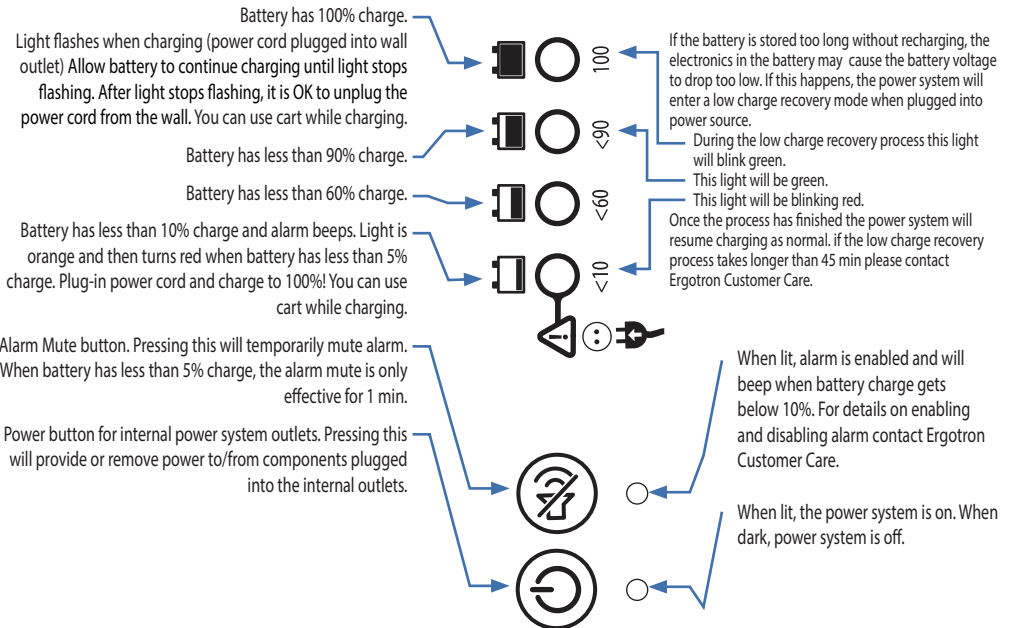

If other lights are flashing red/green it could indicate a power system fault. If this occurs contact Ergotron Customer Care.

NOTE: Frequent operation of the cart while battery charge levels are below 10% may reduce the life of your battery.