

Healthcare Cleaning Recommendations

You can use most hospital-grade, diluted, non-abrasive, non-corrosive cleaning solutions on all plastic and metal surfaces, whether painted, polished or unfinished. See the following pages for a list of tested cleaning solutions by product family.

These are cleaning recommendations only and do not replace your cleaning and infection control requirements. Please consult your infection control administrator or epidemiologist for all cleaning and infection control procedures and processes.

Helpful tips:

- Be sure to test any cleaning solution on a small, hidden area before widespread use.
- Pen and permanent and dry erase markers should be removed with 91% Isopropyl alcohol (generic) and a soft cloth.
- Iodine stains can be removed with commonly used cleaners and a soft cloth.

For your safety and to protect your equipment:

- To avoid the risk of electric shock, do not expose electrical components to water, cleaning solutions or other potentially corrosive liquids or substances.
- Do not use flammable cleaners on cart surfaces due to the proximity to electrical power.
- Never use steel wool or other abrasive materials that will damage the surface finish.
- Do not use strong solvents such as trichloroethylene and acetone as they can damage the surface finish.
- Do not immerse the cart or cart components in liquid or allow liquids to flow into the cart. Wipe all cleaners off the surface immediately using a damp cloth and dry the surface after cleaning.



To support infection control, please clean, sanitize and sterilize all Ergotron equipment prior to first use and frequently while in use, in accordance with applicable health organization and government guidelines. This includes, but is not limited to, the World Health Organization, the Centers for Disease Control and Infection, the National Institutes of Health and healthcare industry guidelines. Guidelines are evolving, so we recommend checking these sites frequently.

TABLE OF CONTENTS

CareFit™

Carts	3
Combos	5
Enclosures	7

StyleView®

Laptop, LCD Pivot, Pole Carts	9
LCD Arm Carts	11
SV10 Carts	13
LCD Pivot Cart with Large Worksurface	15
Combos, Bright White	17
Combos, Polished Aluminum	19
Sit-Stand Vertical Lifts	21

Appendix	23
----------	----



How to Use This Guide

This guide was developed to help customers understand the compatibility of select cleaning agents that have been specifically tested on Ergotron healthcare solutions. Please note, our internal testing focused on the cosmetic impact of the listed solutions and did not account for potential structural changes over time or their effectiveness in cleaning or disinfecting the products.

Active ingredients between similar cleaning agents may vary. Check the relevant manufacturer's website for the current active ingredients list, and be sure to test a small area of the product before applying a cleaning agent to the full solution. Cleaning solutions with similar ingredients listed in this guide may also be compatible. Conduct your own testing before use.

As always, follow the cleaning agent manufacturer's directions, and consult your infection control administrator or epidemiologist for all cleaning procedures and processes. We will update our guide as further testing is complete using additional cleaning agents and products.

KEY

Part numbers:

"X" placeholders represent various drawer configurations and global power options.

Example:

C52-12XX-X applies to C52-1201-1, as well as C52-1211-3.

Product part colors:

Match the designated color for each product part with the product image to understand the tested area.

Compatible:

Internal Ergotron testing showed no cosmetic changes to product parts with selected cleaning agent.

May cause cosmetic changes to material:

Minimal cosmetic changes may become visible after prolonged use; other solutions are recommended.

Not compatible:

Internal Ergotron testing showed cosmetic changes after use; not recommended.

Not tested:

The cleaning agent has not yet been tested on the specified Ergotron product part.

Contact your Ergotron representative or local Customer Care team with any questions about this information. Please refer to page 1 for contact details.



PRODUCT FAMILY: CAREFIT

PRODUCT TYPES: CARTS (WHITE/WARM GREY)







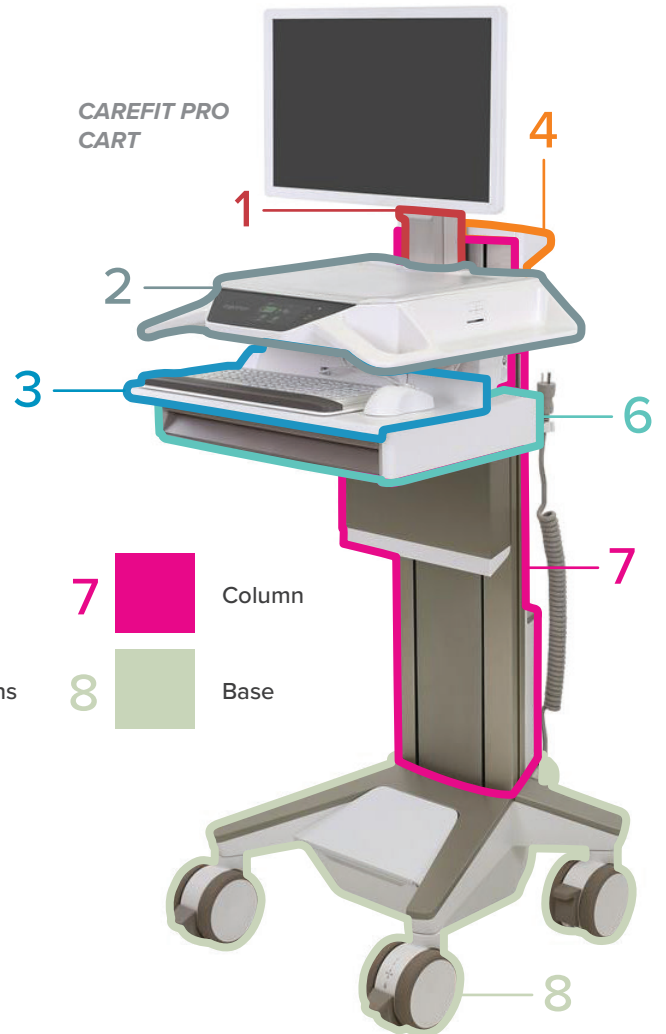
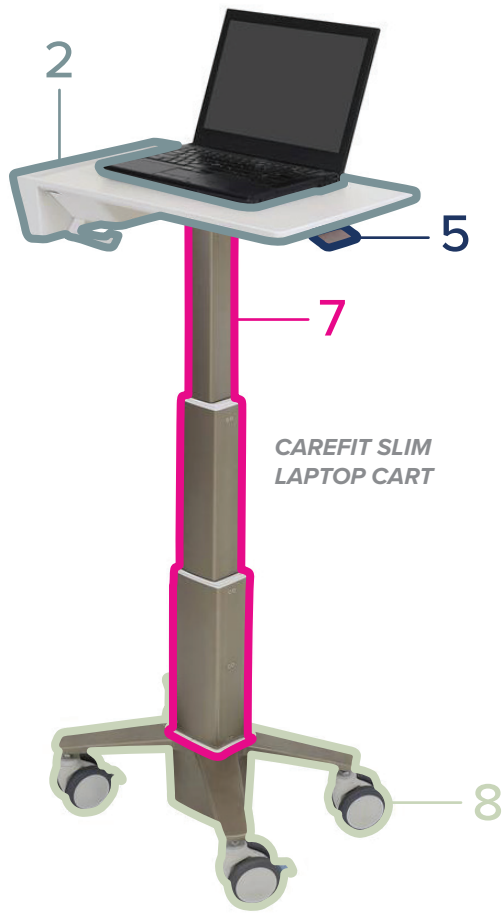
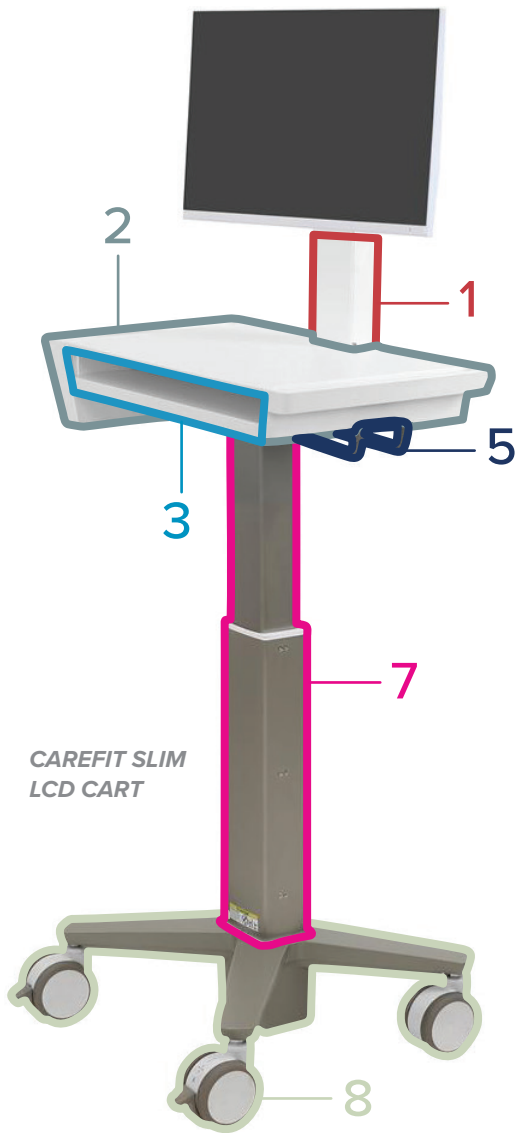

- C50-1100-0
- C50-3500-0
- C50-3510-0
- C52-12XX-X
- C52-22XX-X

Category	Cleaning Agent		Product Part (if applicable)							
	Brand	Type	Arm / Tilt / Riser	Worksurface / Head Unit	Keyboard & Mouse Tray	Handles	Levers / Buttons	Drawers	Column	Base
Alcohol	Isopropyl alcohol (generic), 99%	Liquid	✓	✓	✓	✓	✓	✓	✓	✓
	Sterillium® Comfort Gel™, Hand Antiseptic	Liquid	✓	✓	✓	✓	✓	✓	✓	✓
Ammonia	Windex®, SC Johnson Professional®	Liquid	✓	✓	✓	✓	✓	✓	✓	✓
IPA, Quarternary Ammonium	Super Sani-Cloth®, PDI	Wipes	✓	✓	✓	✓	✓	✓	✓	✓
	Sani-Cloth® Plus	Wipes	✓	✓	✓	✓	✓	✓	✓	✓
Quarternary Ammonium	CaviWipes™, Metrex	Wipes	✓	✓	✓	✓	✓	✓	✓	✓
	Clinell® BCW200 Universal Wipes (green)	Wipes	✓	✓	✓	✓	✓	✓	✓	✓
	Clorox® Versasure® Wipes	Wipes	*	✓	✓	✓	*	✓	✓	*
Ethanol, Quarternary Ammonium	Lysol® Disinfectant Spray	Spray	✓	✓	✓	✓	✓	✓	✓	✓
Bleach	Clorox Healthcare® Bleach Germicidal Wipes	Wipes	✓	✓	✓	✓	✓	✓	✓	✓
Hydrogen Peroxide	Diversey™ Oxivir® Tb Wipes, Virox Technologies	Wipes	✓	*	*	✓	✓	*	✓	✓
	Clorox Healthcare® Hydrogen Peroxide Wipes	Wipes	✓	✓	✓	✓	✓	✓	✓	✓
	Hydrogen Peroxide	Liquid	✓	✓	✓	✓	✓	✓	✓	✓
Peracetic	Clinell® Peracetic Acid Wipes CS25 (red)	Wipes	*	✓	✓	✓	*	✓	✓	*

Product Compatibility

Compatible	✓
May cause cosmetic changes to material	*
Not compatible	■
Not tested	■



- | | | | | | | | | |
|----------|---|-------------------------|----------|---|------------------|----------|--|--------|
| 1 |  | Arm / Tilt / Riser | 4 |  | Handles | 7 |  | Column |
| 2 |  | Worksurface / Head Unit | 5 |  | Levers / Buttons | 8 |  | Base |
| 3 |  | Keyboard & Mouse Tray | 6 |  | Drawers | | | |

PRODUCT FAMILY: CAREFIT
PRODUCT TYPES: COMBOS (WHITE)

45-618-251
 45-619-251
 45-621-251
 45-622-251

Category	Cleaning Agent		Product Part (if applicable)					
	Brand	Type	Tilt / Riser	Arm	Worksurface	Keyboard & Mouse Tray	Wall Track <small>Wall Track Covers hide the Wall Track</small>	Wall Track Covers
Alcohol	Isopropyl alcohol (generic), 99%	Liquid	✓	✓	✓	✓	✓	✓
	Sterillium® Comfort Gel™, Hand Antiseptic	Liquid	✓	✓	✓	✓	✓	✓
Ammonia	Windex®, SC Johnson Professional®	Liquid	✓	✓	✓	✓	✓	✓
IPA, Quarternary Ammonium	Super Sani-Cloth®, PDI	Wipes	✓	✓	✓	✓	✓	✓
	Sani-Cloth® Plus	Wipes	✓	✓	✓	✓	✓	✓
Quarternary Ammonium	CaviWipes™, Metrex	Wipes	✓	✓	✓	✓	✓	✓
	Clinell® BCW200 Universal Wipes (green)	Wipes	✓	✓	✓	✓	✓	✓
	Clorox® Versasure® Wipes	Wipes	✓	✓	✓	✓	✓	✓
Ethanol, Quarternary Ammonium	Lysol® Disinfectant Spray	Spray	✓	✓	✓	✓	✓	✓
Bleach	Clorox Healthcare® Bleach Germicidal Wipes	Wipes	✓	✓	✓	✓	✓	✓
Hydrogen Peroxide	Diversey™ Oxivir® Tb Wipes, Virox Technologies	Wipes	*	*	*	*	*	*
	Clorox Healthcare® Hydrogen Peroxide Wipes	Wipes	✓	✓	✓	✓	✓	✓
	Hydrogen Peroxide	Liquid	✓	✓	✓	✓	✓	✓
Peracetic	Clinell® Peracetic Acid Wipes CS25 (red)	Wipes	✓	✓	✓	✓	✓	✓

Product Compatibility

Compatible 





May cause cosmetic changes to material 

Not compatible 

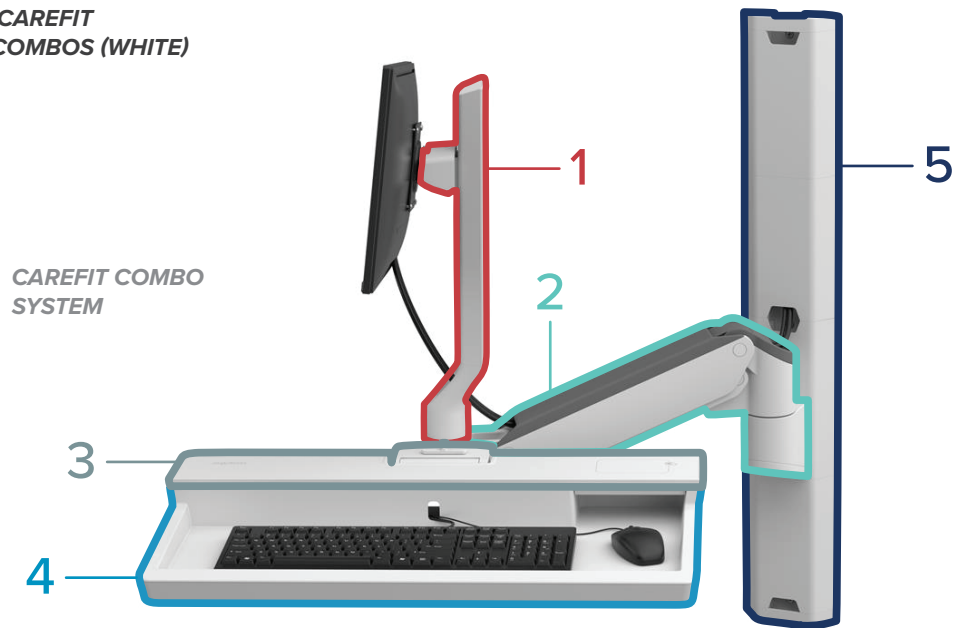
Not tested 

PRODUCT FAMILY: CAREFIT
PRODUCT TYPES: COMBOS (WHITE)



- | | | | | | |
|---|--|--------------|---|---|-----------------------|
| 1 |  | Tilt / Riser | 4 |  | Keyboard & Mouse Tray |
| 2 |  | Arm | 5 |  | Wall Track Covers |
| 3 |  | Worksurface | | | |

PRODUCT FAMILY: CAREFIT
PRODUCT TYPES: ENCLOSURES (BLACK OR WHITE)

61-367-060
 61-367-030

Category	Cleaning Agent		Product Part (if applicable)					
	Brand	Type	Lift Engine	Handles	Worksurface	Keyboard & Mouse Tray	Covers	Wall Covers
Alcohol	Isopropyl alcohol (generic), 99%	Liquid	✓	✓	✓	✓	✓	✓
	Sterillium® Comfort Gel™, Hand Antiseptic	Liquid	✓	✓	✓	✓	✓	✓
Ammonia	Windex®, SC Johnson Professional®	Liquid	✓	✓	✓	✓	✓	✓
IPA, Quarternary Ammonium	Super Sani-Cloth®, PDI	Wipes	✓	✓	✓	✓	✓	✓
	Sani-Cloth® Plus	Wipes	✓	✓	✓	✓	✓	✓
Quarternary Ammonium	CaviWipes™, Metrex	Wipes	✓	✓	✓	✓	✓	✓
	Clinell® BCW200 Universal Wipes (green)	Wipes	✓	✓	✓	✓	✓	✓
	Clorox® Versasure® Wipes	Wipes	✓	✓	✓	✓	✓	✓
Ethanol, Quarternary Ammonium	Lysol® Disinfectant Spray	Spray	✓	✓	✓	✓	✓	✓
Bleach	Clorox Healthcare® Bleach Germicidal Wipes	Wipes	✓	✓	✓	✓	✓	✓
Hydrogen Peroxide	Diversey™ Oxivir® Tb Wipes, Virox Technologies	Wipes	✓	*	*	*	✓	✗
	Clorox Healthcare® Hydrogen Peroxide Wipes	Wipes	✓	✓	✓	✓	✓	✓
	Hydrogen Peroxide	Liquid	✓	✓	✓	✓	✓	✓
Peracetic	Clinell® Peracetic Acid Wipes CS25 (red)	Wipes	✓	✓	✓	✓	✓	✓

Product Compatibility

Compatible 

May cause cosmetic changes to material 





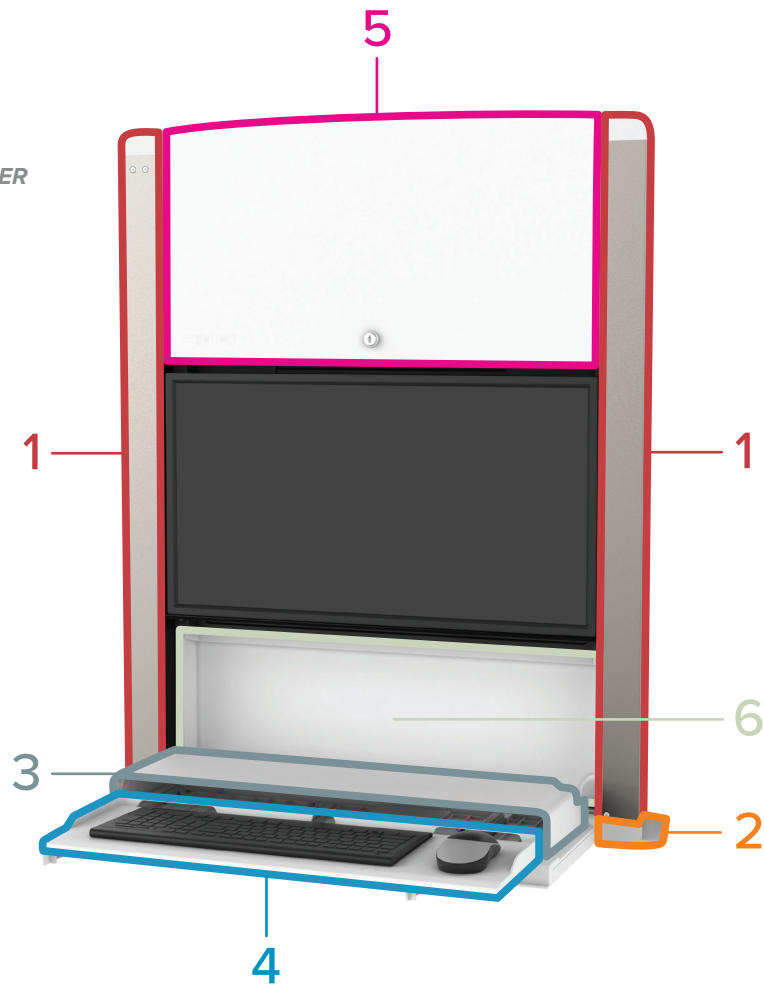

Not compatible 

Not tested 

PRODUCT FAMILY: CAREFIT
PRODUCT TYPES: ENCLOSURES (BLACK OR WHITE)

CAREFIT ENCLOSURE
WALL-MOUNT COMPUTER
WORKSTATION



- | | | | | | |
|---|---|-------------|---|---|-----------------------|
| 1 |  | Lift Engine | 4 |  | Keyboard & Mouse Tray |
| 2 |  | Handles | 5 |  | Covers |
| 3 |  | Worksurface | 6 |  | Wall Covers |

PRODUCT FAMILY: STYLEVIEW

PRODUCT TYPES: CARTS (LAPTOP, LCD PIVOT, POLE – WHITE)

SV40-6100-0 SV42-8302-1
 SV40-6300-0 SV43-11XX-X
 SV41-6100-0 SV43-13XX-X
 SV41-6300-0 SV44-11XX-X
 SV42-6102-X SV44-13XX-X
 SV42-6302-X 24-818-211

			Product Part (if applicable)							
			Arm / Tilt / Riser	Worksurface / Head Unit	Keyboard & Mouse Tray	Handles	Levers / Buttons	Drawers	Column	Base
Alcohol	Isopropyl alcohol (generic), 99%	Liquid	✓	✓	✓	✓	*	✓	✓	*
	Sterillium® Comfort Gel™, Hand Antiseptic	Liquid	✓	✓	✓	✓	✓	✓	✓	✓
Ammonia	Windex®, SC Johnson Professional®	Liquid	✓	✓	✓	✓	✓	✓	✓	✓
IPA, Quarternary Ammonium	Super Sani-Cloth®, PDI	Wipes	✓	✓	✓	✓	*	✓	✓	*
	Sani-Cloth® Plus	Wipes	✓	✓	✓	✓	*	✓	✓	*
Quarternary Ammonium	CaviWipes™, Metrex	Wipes	✓	✓	✓	✓	*	✓	✓	*
	Clinell® BCW200 Universal Wipes (green)	Wipes	✓	✓	✓	✓	*	✓	✓	*
	Clorox® Versasure® Wipes	Wipes	✓	✓	✓	✓	*	✓	✓	*
Ethanol, Quarternary Ammonium	Lysol® Disinfectant Spray	Spray	✓	✓	✓	✓	✓	✓	✓	✓
Bleach	Clorox Healthcare® Bleach Germicidal Wipes	Wipes	✓	✓	✓	✓	*	✓	✓	*
Hydrogen Peroxide	Diversey™ Oxivir® Tb Wipes, Virox Technologies	Wipes	✗	✗	✗	✗	✗	✗	✗	✗
	Clorox Healthcare® Hydrogen Peroxide Wipes	Wipes	✓	✓	✓	✓	*	✓	✓	*
	Hydrogen Peroxide	Liquid	✓	✓	✓	✓	✓	✓	✓	✓
Peracetic	Clinell® Peracetic Acid Wipes CS25 (red)	Wipes	✓	✓	✓	✓	*	✓	✓	*

Category	Cleaning Agent	
	Brand	Type
Alcohol	Isopropyl alcohol (generic), 99%	Liquid
	Sterillium® Comfort Gel™, Hand Antiseptic	Liquid
Ammonia	Windex®, SC Johnson Professional®	Liquid
IPA, Quarternary Ammonium	Super Sani-Cloth®, PDI	Wipes
	Sani-Cloth® Plus	Wipes
Quarternary Ammonium	CaviWipes™, Metrex	Wipes
	Clinell® BCW200 Universal Wipes (green)	Wipes
	Clorox® Versasure® Wipes	Wipes
Ethanol, Quarternary Ammonium	Lysol® Disinfectant Spray	Spray
Bleach	Clorox Healthcare® Bleach Germicidal Wipes	Wipes
Hydrogen Peroxide	Diversey™ Oxivir® Tb Wipes, Virox Technologies	Wipes
	Clorox Healthcare® Hydrogen Peroxide Wipes	Wipes
	Hydrogen Peroxide	Liquid
Peracetic	Clinell® Peracetic Acid Wipes CS25 (red)	Wipes

Product Compatibility

Compatible	✓
May cause cosmetic changes to material	*
Not compatible	✗
Not tested	■



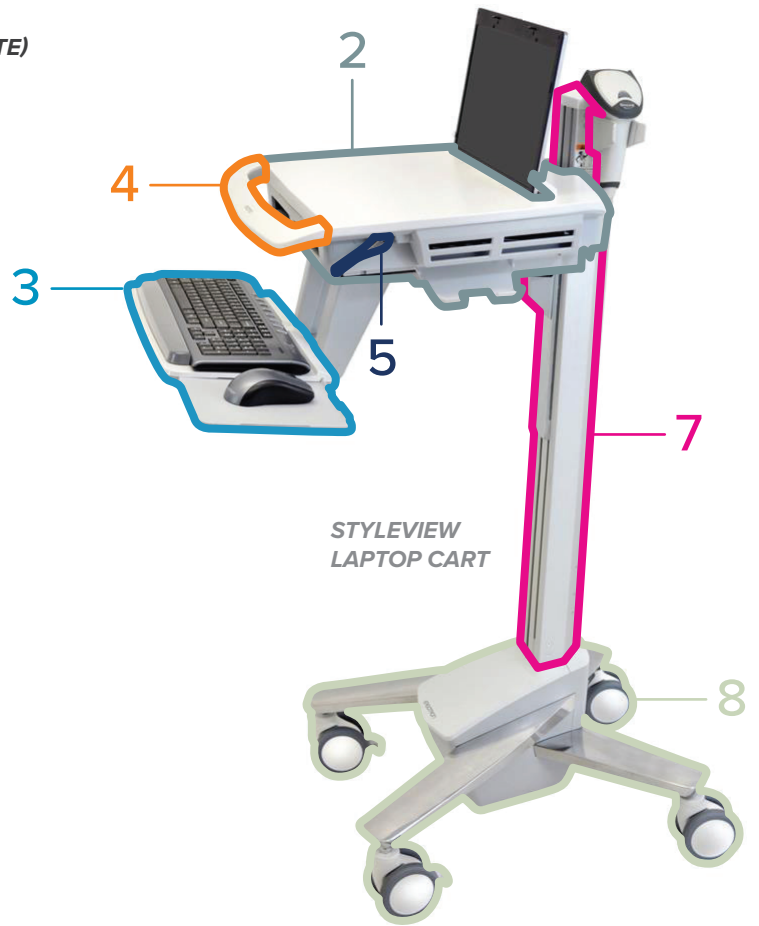
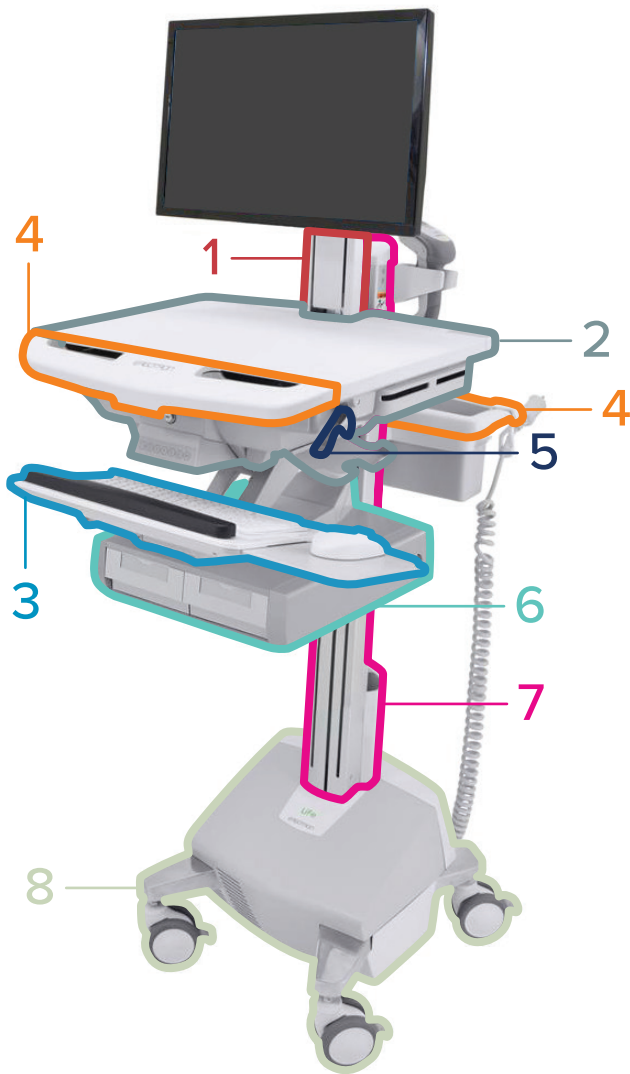



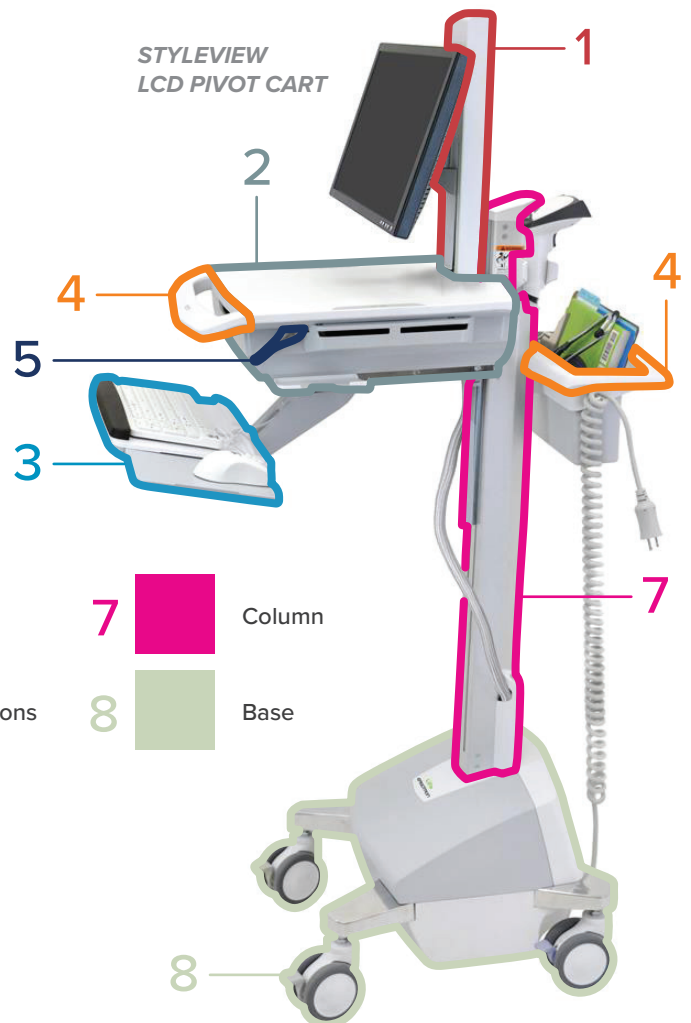

STYLEVIEW LCD CART



STYLEVIEW
LAPTOP CART

STYLEVIEW
LCD PIVOT CART



- | | | | | | | | | |
|----------|---|-------------------------|----------|---|------------------|----------|--|--------|
| 1 |  | Arm / Tilt / Riser | 4 |  | Handles | 7 |  | Column |
| 2 |  | Worksurface / Head Unit | 5 |  | Levers / Buttons | 8 |  | Base |
| 3 |  | Keyboard & Mouse Tray | 6 |  | Drawers | | | |

PRODUCT FAMILY: STYLEVIEW

PRODUCT TYPES: CARTS (LCD ARM — WHITE)

SV41-6200-0
 SV42-6202-X
 SV43-12XX-X
 SV44-12XX-X

Category	Cleaning Agent		Product Part (if applicable)							
	Brand	Type	Arm / Tilt / Riser	Worksurface / Head Unit	Keyboard & Mouse Tray	Handles	Levers / Buttons	Drawers	Column	Base
Alcohol	Isopropyl alcohol (generic), 99%	Liquid	*	✓	✓	✓	*	✓	✓	*
	Sterillium® Comfort Gel™, Hand Antiseptic	Liquid	✓	✓	✓	✓	✓	✓	✓	✓
Ammonia	Windex®, SC Johnson Professional®	Liquid	✓	✓	✓	✓	✓	✓	✓	✓
IPA, Quarternary Ammonium	Super Sani-Cloth®, PDI	Wipes	*	✓	✓	✓	*	✓	✓	*
	Sani-Cloth® Plus	Wipes	*	✓	✓	✓	*	✓	✓	*
Quarternary Ammonium	CaviWipes™, Metrex	Wipes	*	✓	✓	✓	*	✓	✓	*
	Clinell® BCW200 Universal Wipes (green)	Wipes	*	✓	✓	✓	*	✓	✓	*
	Clorox® Versasure® Wipes	Wipes	*	✓	✓	✓	*	✓	✓	*
Ethanol, Quarternary Ammonium	Lysol® Disinfectant Spray	Spray	✓	✓	✓	✓	✓	✓	✓	✓
Bleach	Clorox Healthcare® Bleach Germicidal Wipes	Wipes	*	✓	✓	✓	*	✓	✓	*
Hydrogen Peroxide	Diversey™ Oxivir® Tb Wipes, Virox Technologies	Wipes	■	■	■	■	■	■	■	■
	Clorox Healthcare® Hydrogen Peroxide Wipes	Wipes	*	✓	✓	✓	*	✓	✓	*
	Hydrogen Peroxide	Liquid	✓	✓	✓	✓	✓	✓	✓	✓
Peracetic	Clinell® Peracetic Acid Wipes CS25 (red)	Wipes	*	✓	✓	✓	*	✓	✓	*

Product Compatibility





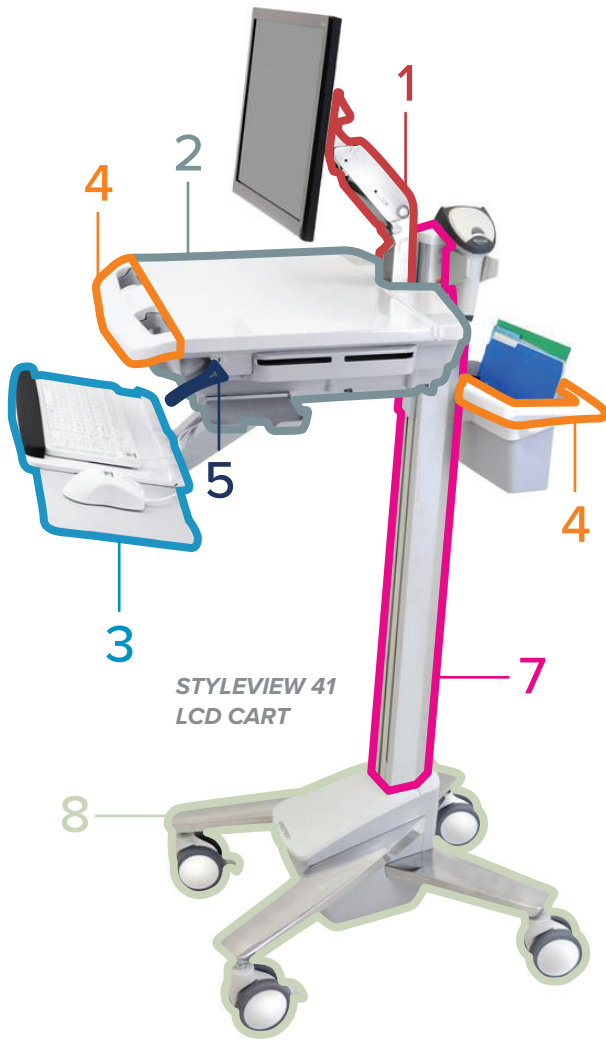

Compatible	✓
May cause cosmetic changes to material	*
Not compatible	■
Not tested	■

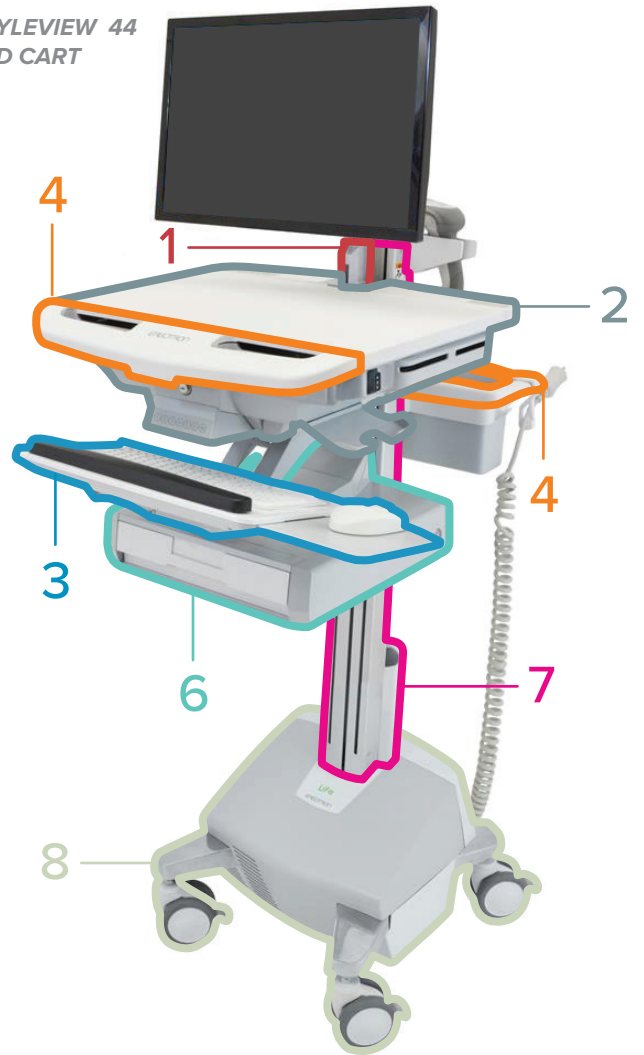
PRODUCT FAMILY: STYLEVIEW
PRODUCT TYPES: CARTS (LCD ARM — WHITE)



**STYLEVIEW 44
 LCD CART**



- | | | | | | | | | |
|----------|---|-------------------------|----------|---|------------------|----------|---|--------|
| 1 |  | Arm / Tilt / Riser | 4 |  | Handles | 7 |  | Column |
| 2 |  | Worksurface / Head Unit | 5 |  | Levers / Buttons | 8 |  | Base |
| 3 |  | Keyboard & Mouse Tray | 6 |  | Drawers | | | |

PRODUCT FAMILY: STYLEVIEW
PRODUCT TYPES: CARTS (WHITE)

SV10-1100-0
 SV10-1400-0
 SV10-1800-0

Category	Cleaning Agent		Product Part (if applicable)					
	Brand	Type	Arm / Tilt / Riser	Worksurface / Head Unit	Handles	Levers / Buttons	Column	Base
Alcohol	Isopropyl alcohol (generic), 99%	Liquid	✓	✓	✓	✓	✓	✓
	Sterillium® Comfort Gel™, Hand Antiseptic	Liquid	✓	✓	✓	✓	✓	✓
Ammonia	Windex®, SC Johnson Professional®	Liquid	✓	✓	✓	✓	✓	✓
IPA, Quarternary Ammonium	Super Sani-Cloth®, PDI	Wipes	✓	✓	✓	✓	✓	✓
	Sani-Cloth® Plus	Wipes	✓	Not tested	✓	✓	✓	✓
Quarternary Ammonium	CaviWipes™, Metrex	Wipes	✓	✓	✓	✓	✓	✓
	Clinell® BCW200 Universal Wipes (green)	Wipes	✓	Not tested	✓	✓	✓	✓
	Clorox® Versasure® Wipes	Wipes	✓	Not tested	✓	✓	✓	✓
Ethanol, Quarternary Ammonium	Lysol® Disinfectant Spray	Spray	✓	Not tested	✓	✓	✓	✓
Bleach	Clorox Healthcare® Bleach Germicidal Wipes	Wipes	✓	✓	✓	✓	✓	✓
Hydrogen Peroxide	Diversey™ Oxivir® Tb Wipes, Virox Technologies	Wipes	Not compatible	✓	Not compatible	Not compatible	✓	Not compatible
	Clorox Healthcare® Hydrogen Peroxide Wipes	Wipes	✓	✓	✓	✓	✓	✓
	Hydrogen Peroxide	Liquid	✓	Not tested	✓	✓	✓	✓
Peracetic	Clinell® Peracetic Acid Wipes CS25 (red)	Wipes	✓	Not tested	✓	✓	✓	✓

Product Compatibility





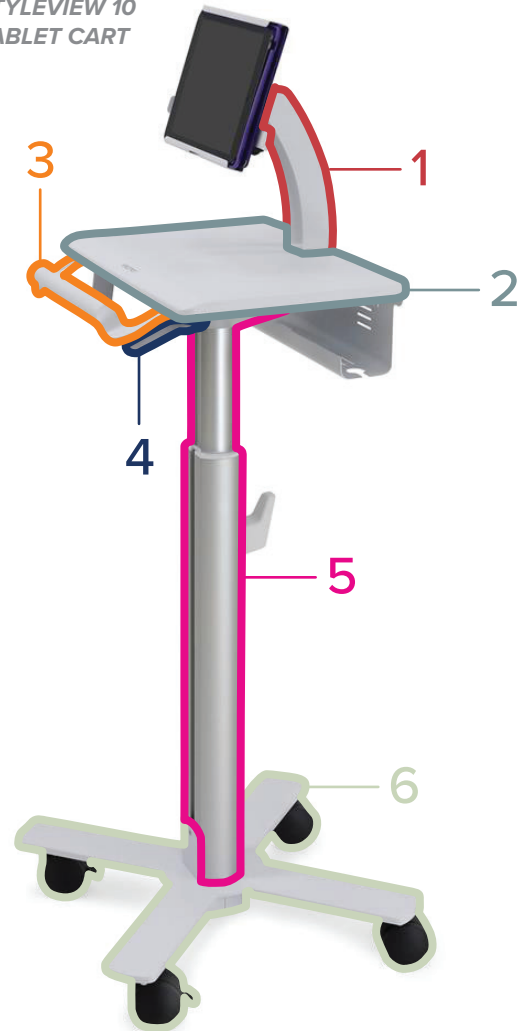
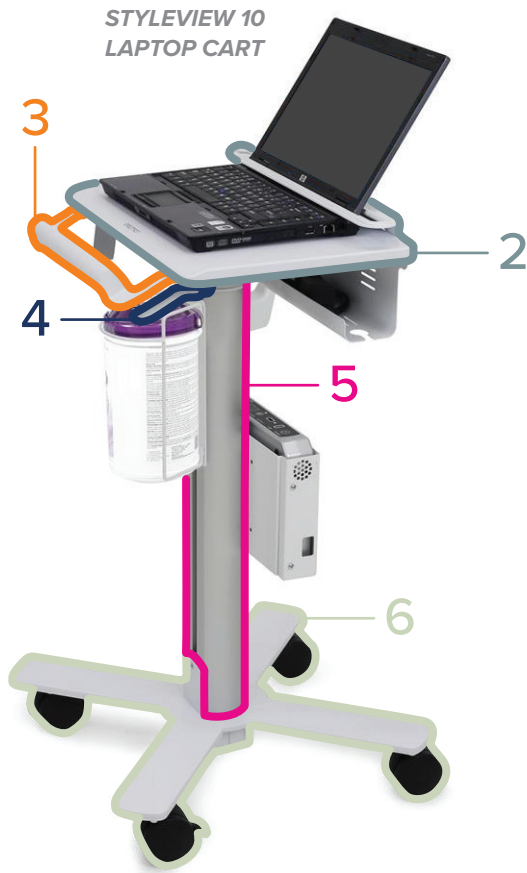

Compatible ✓

May cause cosmetic changes to material *

Not compatible

Not tested



- | | | | | | |
|---|---|-------------------------|---|--|------------------|
| 1 |  | Arm / Tilt / Riser | 4 |  | Levers / Buttons |
| 2 |  | Worksurface / Head Unit | 5 |  | Column |
| 3 |  | Handles | 6 |  | Base |

PRODUCT FAMILY: STYLEVIEW
PRODUCT TYPES: LCD PIVOT CART WITH LARGE WORKSURFACE
(WHITE)

SV41-6320

Category	Cleaning Agent		Product Part (if applicable)					
	Brand	Type	Arm / Tilt / Riser	Worksurface / Head Unit	Handles	Levers / Buttons	Column	Base
Alcohol	Isopropyl alcohol (generic), 99%	Liquid	✓		✓	*	✓	*
	Sterillium® Comfort Gel™, Hand Antiseptic	Liquid	✓		✓	✓	✓	✓
Ammonia	Windex®, SC Johnson Professional®	Liquid	✓		✓	✓	✓	✓
IPA, Quarternary Ammonium	Super Sani-Cloth®, PDI	Wipes	✓		✓	*	✓	*
	Sani-Cloth® Plus	Wipes	✓		✓	*	✓	*
Quarternary Ammonium	CaviWipes™, Metrex	Wipes	✓		✓	*	✓	*
	Clinell® BCW200 Universal Wipes (green)	Wipes	✓		✓	*	✓	*
	Clorox® Versasure® Wipes	Wipes	✓		✓	*	✓	*
Ethanol, Quarternary Ammonium	Lysol® Disinfectant Spray	Spray	✓		✓	✓	✓	✓
Bleach	Clorox Healthcare® Bleach Germicidal Wipes	Wipes	✓		✓	*	✓	*
Hydrogen Peroxide	Diversey™ Oxivir® Tb Wipes, Virox Technologies	Wipes	✗	✗	✗	✗	✓	✗
	Clorox Healthcare® Hydrogen Peroxide Wipes	Wipes	✓		✓	*	✓	*
	Hydrogen Peroxide	Liquid	✓		✓	✓	✓	✓
Peracetic	Clinell® Peracetic Acid Wipes CS25 (red)	Wipes	✓		✓	*	✓	*

Product Compatibility

Compatible 

May cause cosmetic changes to material 





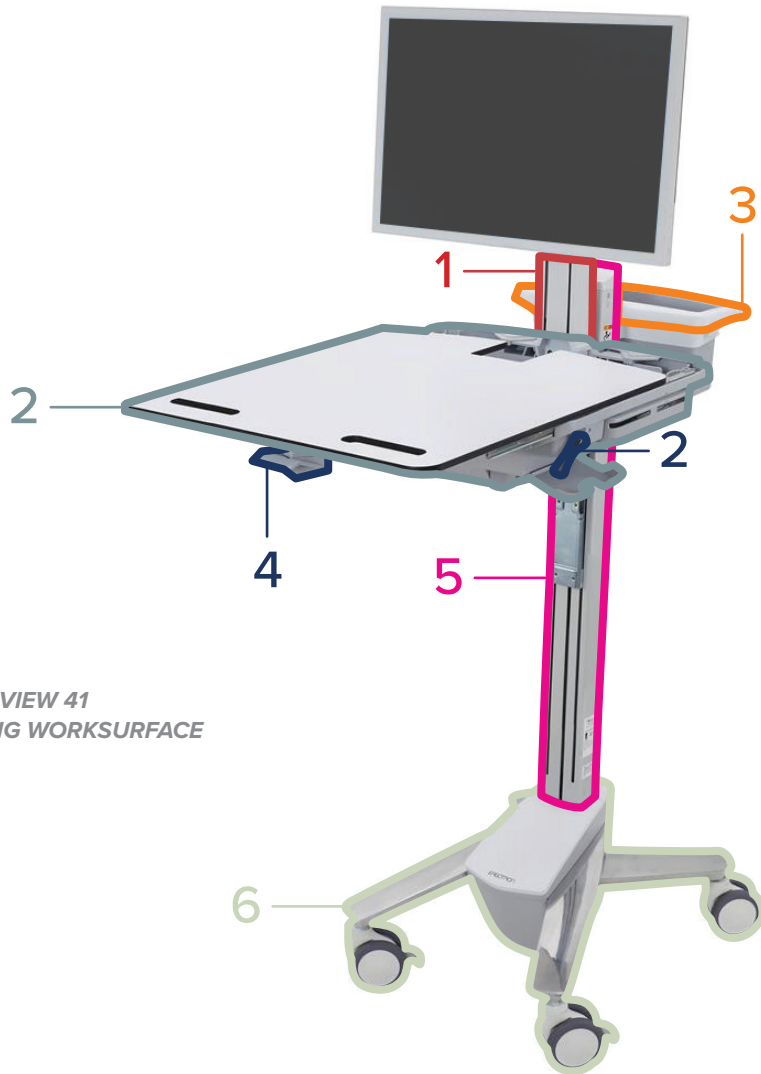

Not compatible 

Not tested 

PRODUCT FAMILY: STYLEVIEW
PRODUCT TYPES: LCD PIVOT CART WITH LARGE WORKSURFACE
(WHITE)



STYLEVIEW 41
SLIDING WORKSURFACE
CART

- | | | | | | |
|---|---|-------------------------|---|--|------------------|
| 1 |  | Arm / Tilt / Riser | 4 |  | Levers / Buttons |
| 2 |  | Worksurface / Head Unit | 5 |  | Column |
| 3 |  | Handles | 6 |  | Base |

PRODUCT FAMILY: STYLEVIEW

PRODUCT TYPES: COMBOS (WHITE)

- 45-583-216 45-272-216
- 45-260-216 45-270-216
- 45-266-216 45-273-216
- 45-594-216 45-271-216
- 45-595-216

Category	Cleaning Agent		Product Part (if applicable)					
	Brand	Type	Tilt / Riser	Arm	Worksurface	Keyboard & Mouse Tray	Wall Track	Wall Track Covers
Alcohol	Isopropyl alcohol (generic), 99%	Liquid	✓	✓	✓	✓	✓	✓
	Sterillium® Comfort Gel™, Hand Antiseptic	Liquid	✓	✓	✓	✓	✓	✓
Ammonia	Windex®, SC Johnson Professional®	Liquid	✓	✓	✓	✓	✓	✓
IPA, Quarternary Ammonium	Super Sani-Cloth®, PDI	Wipes	✓	✓	✓	✓	✓	✓
	Sani-Cloth® Plus	Wipes	✓	✓	✓	✓	✓	✓
Quarternary Ammonium	CaviWipes™, Metrex	Wipes	✓	✓	✓	✓	✓	✓
	Clinell® BCW200 Universal Wipes (green)	Wipes	✓	✓	✓	✓	✓	✓
	Clorox® Versasure® Wipes	Wipes	✓	✓	✓	✓	✓	✓
Ethanol, Quarternary Ammonium	Lysol® Disinfectant Spray	Spray	✓	✓	✓	✓	✓	✓
Bleach	Clorox Healthcare® Bleach Germicidal Wipes	Wipes	✓	✓	✓	✓	✓	✓
Hydrogen Peroxide	Diversey™ Oxivir® Tb Wipes, Virox Technologies	Wipes	*	✓	*	*	✓	✓
	Clorox Healthcare® Hydrogen Peroxide Wipes	Wipes	✓	✓	✓	✓	✓	✓
	Hydrogen Peroxide	Liquid	✓	✓	✓	✓	✓	✓
Peracetic	Clinell® Peracetic Acid Wipes CS25 (red)	Wipes	✓	✓	✓	✓	✓	✓

Product Compatibility





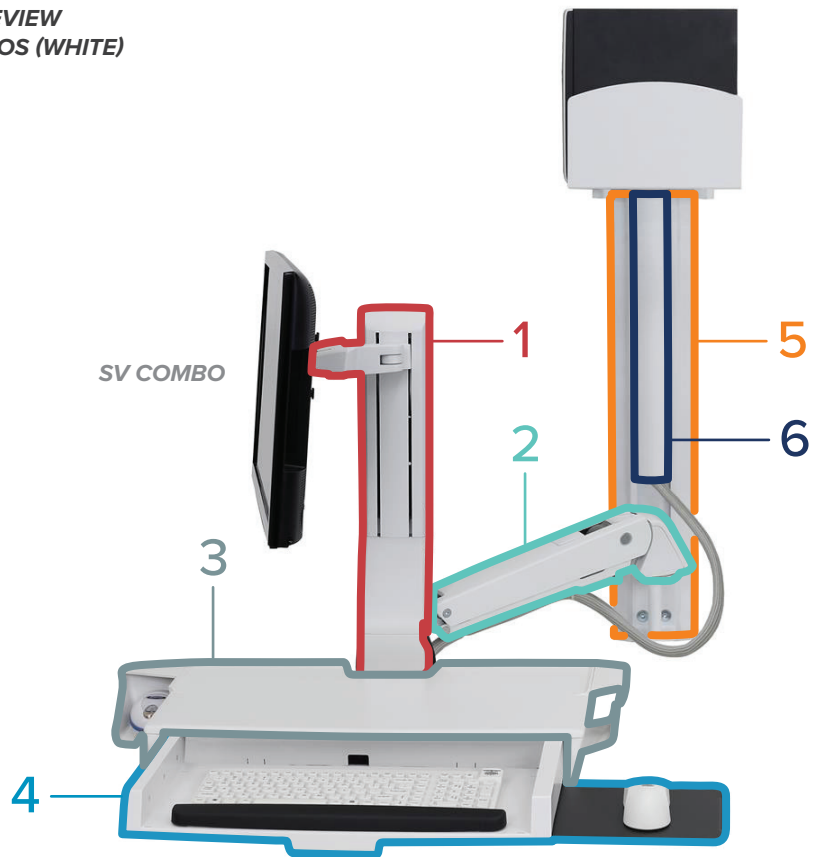

Compatible 

May cause cosmetic changes to material 

Not compatible 

Not tested 



- | | | | | | |
|---|---|--------------|---|---|-----------------------|
| 1 |  | Tilt / Riser | 4 |  | Keyboard & Mouse Tray |
| 2 |  | Arm | 5 |  | Wall Track |
| 3 |  | Worksurface | 6 |  | Wall Track Covers |

PRODUCT FAMILY: STYLEVIEW

PRODUCT TYPES: COMBOS (POLISHED ALUMINUM)

- 45-583-026 45-272-026
- 45-260-026 45-270-026
- 45-266-026 45-273-026
- 45-594-026 45-271-026
- 45-595-026

Category	Cleaning Agent		Product Part (if applicable)					
	Brand	Type	Tilt / Riser	Arm	Worksurface	Keyboard & Mouse Tray	Wall Track	Wall Track Covers
Alcohol	Isopropyl alcohol (generic), 99%	Liquid	✓	*	✓	✓	*	✓
	Sterillium® Comfort Gel™, Hand Antiseptic	Liquid	✓	✓	✓	✓	✓	✓
Ammonia	Windex®, SC Johnson Professional®	Liquid	✓	✓	✓	✓	✓	✓
IPA, Quarternary Ammonium	Super Sani-Cloth®, PDI	Wipes	✓	*	✓	✓	*	✓
	Sani-Cloth® Plus	Wipes	✓	*	✓	✓	*	✓
Quarternary Ammonium	CaviWipes™, Metrex	Wipes	✓	*	✓	✓	*	✓
	Clinell® BCW200 Universal Wipes (green)	Wipes	✓	*	✓	✓	*	✓
	Clorox® Versasure® Wipes	Wipes	✓	*	✓	✓	*	✓
Ethanol, Quarternary Ammonium	Lysol® Disinfectant Spray	Spray	✓	✓	✓	✓	✓	✓
Bleach	Clorox Healthcare® Bleach Germicidal Wipes	Wipes	✓	*	✓	✓	*	✓
Hydrogen Peroxide	Diversey™ Oxivir® Tb Wipes, Virox Technologies	Wipes	✗	✗	✗	✗	✗	✓
	Clorox Healthcare® Hydrogen Peroxide Wipes	Wipes	✓	*	✓	✓	*	✓
	Hydrogen Peroxide	Liquid	✓	✓	✓	✓	✓	✓
Peracetic	Clinell® Peracetic Acid Wipes CS25 (red)	Wipes	✓	*	✓	✓	*	✓

Product Compatibility

Compatible 





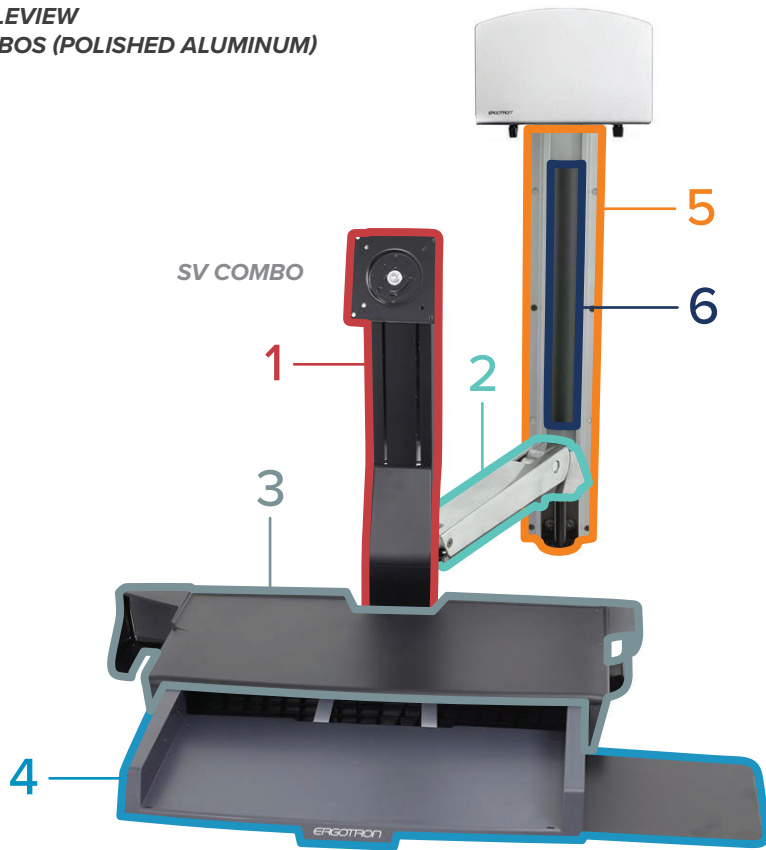

May cause cosmetic changes to material 

Not compatible 

Not tested 

PRODUCT FAMILY: STYLEVIEW
PRODUCT TYPES: COMBOS (POLISHED ALUMINUM)



- | | | | | | |
|---|---|--------------|---|---|-----------------------|
| 1 |  | Tilt / Riser | 4 |  | Keyboard & Mouse Tray |
| 2 |  | Arm | 5 |  | Wall Track |
| 3 |  | Worksurface | 6 |  | Wall Track Covers |

PRODUCT FAMILY: STYLEVIEW

PRODUCT TYPES: SIT-STAND VERTICAL LIFTS (WHITE OR BLACK)

61-080-062

61-080-085

61-081-062

61-081-085

Category	Cleaning Agent		Product Part (if applicable)			
	Brand	Type	Lift Engine	Handles	Worksurface	Keyboard & Mouse Tray
Alcohol	Isopropyl alcohol (generic), 99%	Liquid	✓	✓		✓
	Sterillium® Comfort Gel™, Hand Antiseptic	Liquid	✓	✓		✓
Ammonia	Windex®, SC Johnson Professional®	Liquid	✓	✓		✓
IPA, Quarternary Ammonium	Super Sani-Cloth®, PDI	Wipes	✓	✓		✓
	Sani-Cloth® Plus	Wipes	✓	✓		✓
Quarternary Ammonium	CaviWipes™, Metrex	Wipes	✓	✓		✓
	Clinell® BCW200 Universal Wipes (green)	Wipes	✓	✓		✓
	Clorox® Versasure® Wipes	Wipes	✓	✓		✓
Ethanol, Quarternary Ammonium	Lysol® Disinfectant Spray	Spray	✓	✓		✓
Bleach	Clorox Healthcare® Bleach Germicidal Wipes	Wipes	✓	✓		✓
Hydrogen Peroxide	Diversey™ Oxivir® Tb Wipes, Virox Technologies	Wipes	*	*		*
	Clorox Healthcare® Hydrogen Peroxide Wipes	Wipes	✓	✓		✓
	Hydrogen Peroxide	Liquid	✓	✓		✓
Peracetic	Clinell® Peracetic Acid Wipes CS25 (red)	Wipes	✓	✓		✓

Product Compatibility

Compatible



May cause cosmetic changes to material



Not compatible



Not tested





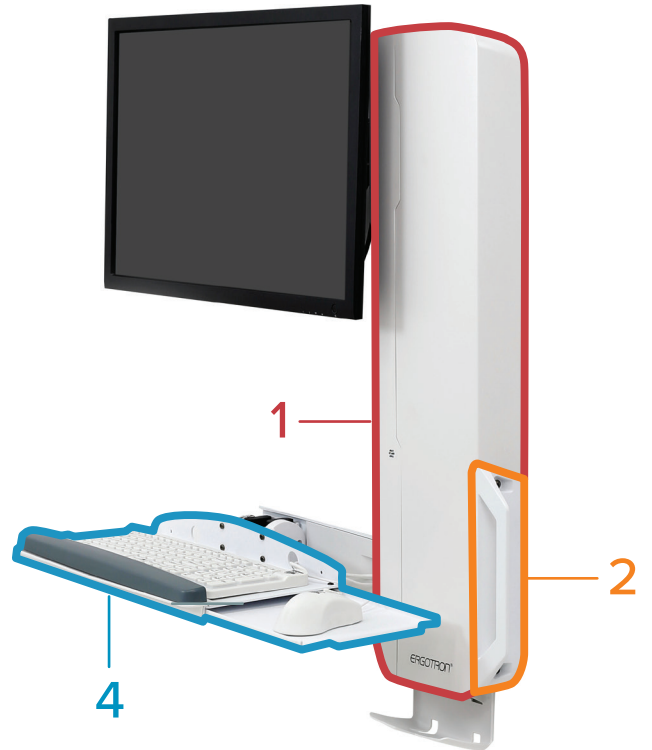
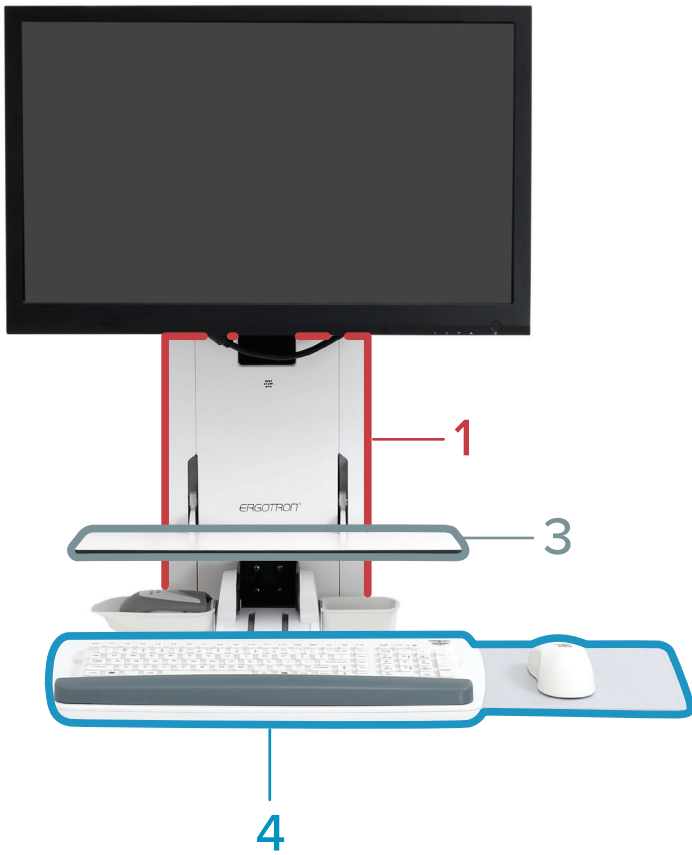

PRODUCT FAMILY: STYLEVIEW
PRODUCT TYPES: SIT-STAND VERTICAL LIFTS (WHITE OR BLACK)

STYLEVIEW SIT-STAND VERTICAL LIFT
HIGH-TRAFFIC AREAS

STYLEVIEW SIT-STAND VERTICAL LIFT
PATIENT ROOM



- | | | | | | |
|---|---|-------------|---|---|-----------------------|
| 1 |  | Lift Engine | 3 |  | Worksurface |
| 2 |  | Handles | 4 |  | Keyboard & Mouse Tray |

Appendix

The active ingredients for each cleaning agent at the time of testing are listed below. Active ingredients may change, so be sure to check the relevant manufacturer's website for the current active ingredients list.

Cleaning Agent		Active Ingredients
Brand	Type	
Isopropyl alcohol (generic), 99%	Liquid	Isopropyl alcohol 99%
Sterillium® Comfort Gel™, Hand Antiseptic	Liquid	Ethyl alcohol 85%
Windex®, SC Johnson Professional®	Liquid	Ammonium Hydroxide, Isopropanolamine, 2-Hexoxyethanol
Super Sani-Cloth®, PDI	Wipes	Isopropyl alcohol 55.5%, Quaternary ammonium compounds, C12-18-alkyl [(ethylphenyl) methyl] dimethyl, chlorides 0.25%, Alkyl Dimethyl Benzyl Ammonium Chloride 0.25%
Sani-Cloth® Plus	Wipes	Isopropanol 10–20%, 2-Butoxyethanol < 5%, Quaternary ammonium compounds, C12–18-alkyl [(ethylphenyl) methyl] dimethyl, chlorides 0.125%, Benzyl-C12–18-alkyldimethyl ammonium chlorides 0.125%
CaviWipes™, Metrex	Wipes	Propan-2-ol, isopropyl alcohol, isopropanol 17.20%, 2-Butoxyethanol, ethylene glycol monobutyl ether, butyl cellosolve 1–5%, Benzethonium Chloride (QA) 0.28%
Clinell® BCW200 Universal Wipes (green)	Wipes	2-Phenoxyethanol 0.6%, Benzalkonium chloride 0.6%, Didecyldimethyl ammonium chloride 0.6%, Biphenyl-2-ol 0.1%
Clorox®Versasure® Wipes	Wipes	0.25% n-Alkyl (C14, 60%; C16, 30%; C12, 5%; C18, 5%) Dimethyl Benzyl Ammonium Chloride, 0.25% n-Alkyl (C12, 68%; C14, 32%) Dimethyl Ethylbenzyl Ammonium Chloride
Lysol® Disinfectant Spray	Spray	Ethanol, Alkyl (50% C14, 40% C12, 10% C16) Dimethyl benzyl ammonium saccharinate
Clorox Healthcare® Bleach Germicidal Wipes	Wipes	Sodium hypochlorite NaOCl 0.55%
Diversey™ Oxivir® Tb Wipes, Virox Technologies	Wipes	Hydrogen peroxide 0.5%
Clorox Healthcare® Hydrogen Peroxide Wipes	Wipes	Hydrogen peroxide H2O2 1.4%
Hydrogen Peroxide	Liquid	Hydrogen peroxide 3%
Clinell® Peracetic Acid Wipes CS25 (red)	Wipes	Sodium Percarbonate ≤50%, Citric Acid ≤15%, Tetraacetythylenediamine ≤ 25%